

Service Manual

Color Television

Simplified

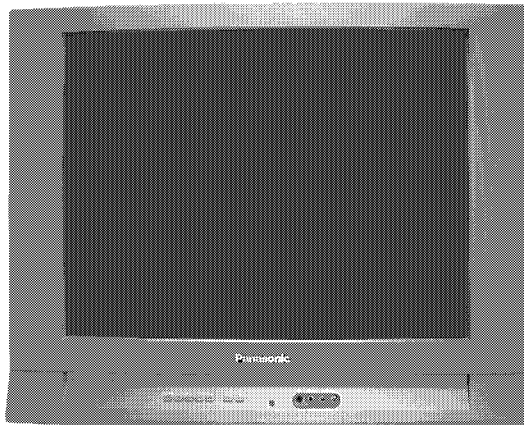

CT-27C8G
CT-27G8G
CT-27G8UG
CT-27L8G
CT-27L8UG
CT-27L8SG
NA10

This simplified service manual is issued to add listed models to the main service manual order No. MTNC030623C1(CT-25L8G). A complete parts list and schematics are included in this simplified service manual. Please file and use this simplified service manual together with the main service manual Order No. MTNC030623C1(CT-25L8G).

WARNING

This service information is designed for experienced repair technicians only and is not designed for use by the general public. It does not contain warnings or cautions to advise non-technical individuals of potential dangers in attempting to service a product. Products powered by electricity should be serviced or repaired only by experienced professional technicians. Any attempt to service or repair the product or products dealt with in this service information by anyone else could result in serious injury or death.

IMPORTANT SAFETY NOTICE

There are special components used in this equipment which are important for safety. These parts are marked by  in the Schematic Diagrams, Circuit Board Diagrams, Exploded Views and Replacement Parts List. It is essential that these critical parts should be replaced with manufacturer's specified parts to prevent shock, fire or other hazards. Do not modify the original design without permission of manufacturer.

CONTENTS

	Page		Page
1 Safety precautions	3	5 Receiver feature table	7
2 Service notes	4	6 Board description table	7
2.1. X-Ray Protection Circuit Check & Adjustments	5	7 TV Location of controls	8
3 EEPROM replacement	5	8 Location of controls (remote)	9
4 About lead free solder (PbF)	6	8.1. EUR7713010	9

Panasonic®

Copyright 2003 Matsushita Electric Corporation of America. All rights reserved. Unauthorized copying and distribution is a violation of law.

8.2. EUR7613Z10	10	15 Conductor Views	23
9 Disassembly for service	11	15.1. A-Board Printed Circuit (Left Side)	24
9.1. Disassembly for CRT replacement	11	15.2. A-Board & C Board Printed Circuit (Right Side)	25
9.2. Back Cover Removal	12	16 Block Diagrams	26
10 Chassis service adjustment procedures	13	16.1. Video Signal Block Diagram	27
11 Service mode (electronic adjustments)	14	16.2. Audio Signal Block Diagram	28
11.1. Service adjustment default values for items	15	17 Schematics	29
12 Service adjustments (electronic controls)	16	17.1. English Schematic Notes	30
12.1. Sub-Brightness and ContrastService DAC adjustment (BRIGH, CONT)	16	17.2. Notas de Esquemáticos en Español	31
12.2. Color output adjustmentService DAC adjustment (COLOR, TINT)	16	17.3. A-Board Schematic TNP2AH047GA/GB (page 1 of 4)	32
12.3. Color output adjustmentService DAC adjustment(COLOR, TINT, B-Y_G)	16	17.4. A-Board Schematic TNP2AH047GA/GB (page 2 of 4)	33
12.4. Color temperature adjustment(B/W Tracking)Service DAC Adjust.(CUT R) (CUT G) (CUT B) (R DR) (B DR)	17	17.5. A-Board Schematic TNP2AH047GA/GB (page 3 of 4)	34
12.5. Deflection adjustments	17	17.6. A-Board Schematic TNP2AH047GA/GB (page 4 of 4)	35
13 Identification of Components	19	17.7. Voltages	36
13.1. Chassis Components	19	17.8. Waveforms	38
14 Reference for PDF Colors	22	18 Parts Location	39
		19 Parts List	40
		19.1. Parts List Notes	40
		19.2. Parts List	41

1 Safety precautions

General guidelines

An isolation transformer should always be used during the servicing of a receiver whose chassis is not isolated from AC power line. Use a transformer of adequate power rating as this protects the technician from accidents resulting in personal injury from electrical shocks. It will also protect the receiver from being damaged by accidental shorting that may occur during servicing.

When servicing, observe the original lead dress, especially in the high voltage circuit. Replace all damaged parts (also parts that show signs of overheating.)

Always replace protective devices, such as fish paper, isolation resistors and capacitors, and shields after servicing the receiver. Use only manufacturer's recommended rating for fuses, circuits breakers, etc.

High potentials are present when this receiver is operating. Operation of the receiver without the rear cover introduces danger for electrical shock. Servicing should not be performed by anyone who is not thoroughly familiar with the necessary precautions when servicing high voltage equipment.

Extreme care should be practiced when handling the picture tube. Rough handling may cause it to implode due to atmospheric pressure. (14.7 lbs per sq. in.). Do not nick or scratch the glass or subject it to any undue pressure. When handling, use safety goggles and heavy gloves for protection. Discharge the picture tube by shorting the anode to chassis ground (not to the cabinet or to other mounting hardware). When discharging connect cold ground (i.e. dag ground lead) to the anode with a well insulated wire or use a grounding probe. Avoid prolonged exposure at close range to unshielded areas of the picture tube to prevent exposure to x ray radiation.

The test picture tube used for servicing the chassis at the bench should incorporate safety glass and magnetic shielding. The safety glass provide shielding for the tube viewing area against x ray radiation as well as implosion. The magnetic shield limits the x ray radiation around the bell of the picture tube in addition to the restricting magnetic effects. When using a picture tube test jig for service, ensure that the jig is capable of handling 50kV without causing x ray radiation.

Before returning a serviced receiver to the owner, the service technician must thoroughly test the unit to ensure that is completely safe to operate. Do not use a line isolation transformer when testing.

Leakage current cold check

Unplug the A.C. cord and connect a jumper between the two plug prongs. Measure the resistance between the jumpered AC plug and expose metallic parts such as screwheads, antenna terminals, control shafts, etc. If the exposed metallic part has a return path to the chassis, the reading should be between 240k Ω and 5.2M Ω . If the exposed metallic part does not have a return path to the chassis, the reading should be infinite.

Leakage current hot check

Plug the AC cord directly into the AC outlet. Do not use an isolation transformer during the check.

Connect a 1.5k Ω 10 watt resistor in parallel with a 0.15 μ F capacitor between an exposed metallic part and ground. Use earth ground, for example a water pipe.

Using a DVM with a 1000 ohms/volt sensitivity or higher, measure the AC potential across the resistor.

Repeat the procedure and measure the voltage present with all other exposed metallic parts.

Verify that any potential does not exceed 0.75 volt RMS. A leakage current tester (such a Simpson model 229, Sencore model PR57 or equivalent) may be used in the above procedure, in which case any current measure must not exceed 0.5 milliamp. If any measurement is out of the specified limits, there is a possibility of a shock hazard and the receiver must be repaired and rechecked before it is returned to the customer.

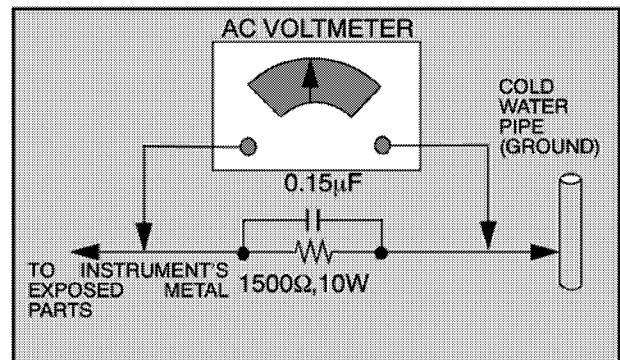

Hot check circuit

Insulation test

Connect an insulation tester between an exposed metallic part and A.C. line. Apply 1080VAC/60Hz for 1 second. Confirm that the current measurement is 0.5mA ~ 2.0mA. Repeat test with other metallic exposed parts.

X ray radiation

WARNING

The potential source of x ray radiation in the TV set is in the high voltage section and the picture tube.

NOTE

It is important to use an accurate, calibrated high voltage meter.

Set the brightness, picture, sharpness and color controls to minimum.

Measure the high voltage. The high voltage should be 29.25 \pm 1.25kV. If the upper limit is out of tolerance, immediate service and correction is required to insure safe operation and to prevent the possibility of premature component failure.

Horizontal oscillator disable circuit test

This test must be performed as a final check before the receiver is returned to the customer. See horizontal oscillator disable circuit procedure check in this manual.

2 Service notes

NOTE

These components are affixed with glue. Be careful not to break or damage any foil under the component or at the pins of the ICs when removing. Usually applying heat to the component for a short time while twisting with tweezers will break the component loose.

Leadless chip component (surface mount)

Chip components must be replaced with identical chips due to critical foil track spacing. There are no holes in the board to mount standard transistors or diodes. Some chips capacitor or resistor board solder pads may have holes through the board, however the hole diameter limits standard resistor replacement to 1/8 watt. Standard capacitor may also be limited for the same reason. It is recommended that identical components be used.

Chip resistor have a three digit numerical resistance code, 1st and 2nd significant digits and a multiplier. Example: 162 = 1600 or 1.6kΩ resistor, 0 = 0Ω (jumper).

Chip capacitors generally do not have the value indicated on the capacitor. The color of the component indicates the general range of the capacitance.

Chip transistors are identified by a two letter code. The first letter indicates the type and the second letter, the grade of transistor.

Chip diodes have a two letter identification code as per the code chart and are a dual diode pack with either common anode or common cathode. Check the parts list for correct diode number.

Component removal

1. Use solder wick to remove solder from component end caps or terminal.
2. Without pulling up, carefully twist the component with tweezers to break the adhesive.
3. Do not reuse removed leadless or chip components since they are subject to stress fracture during removal.

Chip component installation

1. Put a small amount of solder on the board soldering pads.
2. Hold the chip component against the soldering pads with tweezers or with a miniature alligator clip and apply heat to the pad area with a 30 watt iron until solder flows. Do not apply heat for more than 3 seconds.

Chip components

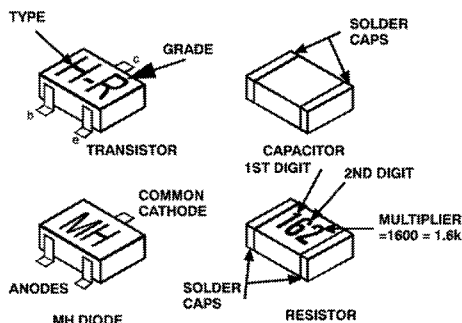

How to replace flat ic (required tools)

1. Remove the solder from all of the pins of a Flat IC by using a desolder braid

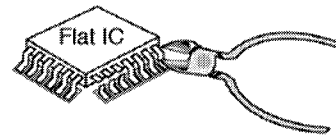

2. Put the iron wire under the pins of the Flat IC and pull it in the direction indicated while heating the pins using a soldering iron. A small awl can be used instead of the iron wire.

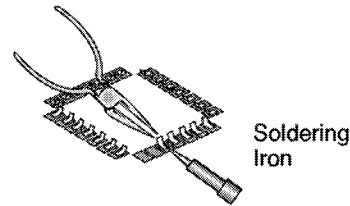

3. Remove the solder from all the pads of the Flat IC by using a de solder braid

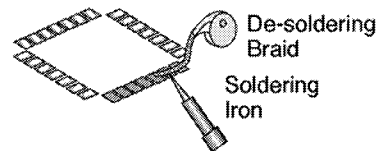

4. Position the new Flat IC in place (apply the pins of the Flat IC to the soldering pads where the pins need to be soldered). Properly determine the positions of the soldering pads and pins by correctly aligning the polarity symbol

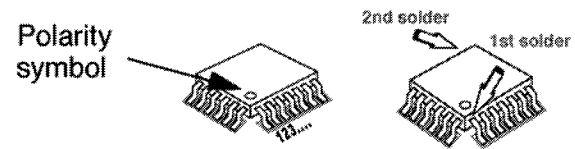

5. Solder all pins to the soldering pads using a fine tipped soldering iron

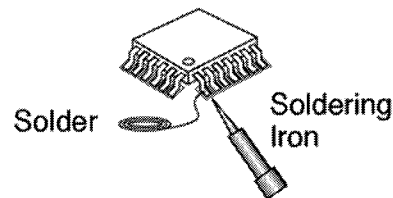

6. Check with a magnifier for solder bridge between the pins or for dry joint between pins and soldering pads. To remove a solder bridge, use a de solder braid as shown in the figure below



IMPORTANT

To protect against possible damage to the solid state devices due to arcing or static discharge, make certain that all ground wires and CRT DAG wire are securely connected.

CAUTION

The power supply circuit is above earth ground and the chassis cannot be polarized. Use an isolation transformer when servicing the receiver to avoid damage to the test equipment or to the chassis. Connect the test equipment to the proper ground (hot) or (cold) when servicing, or incorrect voltages will be measured.

2.1. X-Ray Protection Circuit Check & Adjustments

This test must be performed as final check before the receiver is returned to the customer. If voltages are out of tolerance, immediate service and correction is required to insure safe operation and to prevent the possibility of premature component failure.

Equipment:

1. Isolation transformer.
2. High voltage meter.
3. D.C. Ammeter
4. Short jumper.
5. HHS jig (See figure below).

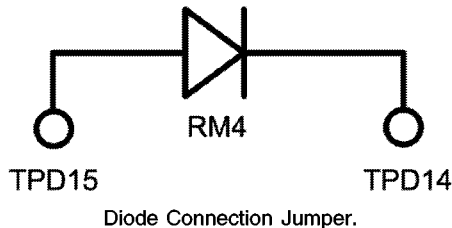

Preparation:

1. Make sure the receiver is turned off.
2. Connect the receiver to an isolation transformer.
3. Connect the ammeter serial from the flyback anode lead to the picture tube anode socket.
4. Prepare short jumper and HHS jig.

Procedure:

1. Connect the short jumper between TPD16 & TPD17.
2. Connect the jumper diode between TPD14 and TPD15 (anode connected to TPD15 and cathode to TPD14).
3. Apply 75VAC to AC input of isolation transformer.
4. Turn the receiver on.
5. Apply a monoscope pattern.
6. Set customer picture and brightness controls to the minimum.
7. Set current within 50 μ A to 100 μ A by changing the picture and bright controls.
8. Slowly increase AC voltage at the input of the isolation transformer and confirm HHS voltage measure **33kV**.
9. Turn power off and remove jigs.

3 EEPROM replacement

If a new EEPROM integrated circuit is replaced for servicing, follow the next procedure once that the memory is properly assembled:

1. Enter to service mode.
2. Turn the TV set ON.
3. Once inside service mode the first image that appears on-screen is the ID1 register with the respective address value (FF) like the image below.

Note:

All 3 registers (ID1, ID2, ID3) should appear with FF values if a new EEPROM is assembled.

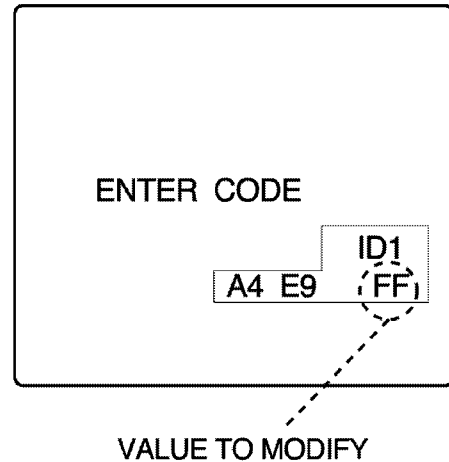

4. With "VOL" keys adjust the correct value according with the service adjustment table (see "Service Mode" section on page 15).
5. Change to the next ID switch register with "CH" keys and repeat the same procedure as step 4.
6. When replacing a new EEPROM be sure to set the correct ID switch values for each model.
7. Once that all 3 registers are set with the correct address value, perform all of the remaining adjustments and servicing.

IMPORTANT:

Correct ID switch configuration should be input when replacing EEPROM for each television model, otherwise if wrong values are configured, the television software will not function accordingly and properly.

4 About lead free solder (PbF)

NOTE

Lead is listed as (Pb) in the periodic table of elements.

In the information below, Pb will refer to lead solder, and PbF will refer to Lead Free Solder.

The lead free solder used in our manufacturing process and discussed below is (Sn+Ag+Cu).

That is Tin (Sn), Silver (Ag) and Copper (Cu) although other types are available.

This model uses Pb Free solder in it's manufacture due to environmental conservation issues. For service and repair work, we'd suggest the use of Pb free solder as well, although Pb solder may be used.

PCBs manufactured using lead free solder will have the "PbF" or a leaf symbol stamped on the back of PCB.



CAUTION

- Pb free solder has a higher melting point than standard solder. Typically the melting point is 50 ~ 70 °F (30 ~ 40 °C) higher. Please use a high temperature soldering iron and set it to 700 ± 20 °F (370 ± 10 °C).
- Pb free solder will tend to splash when heated too high (about 1100 °F or 600 °C).
If you must use Pb solder, please completely remove all of the Pb free solder on the pins or solder area before applying Pb solder. If this is not practical, be sure to heat the Pb free solder until it melts, before applying Pb solder.
- After applying PbF solder to double layered boards, please check the component side for excess solder which may flow onto the opposite side.

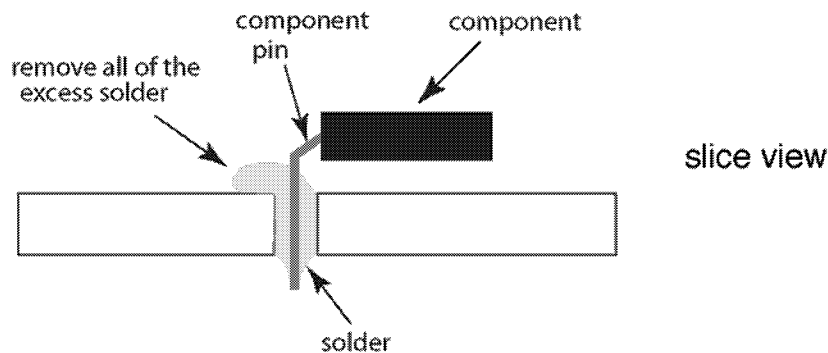

Suggested Pb free solder

There are several kinds of Pb free solder available for purchase. This product uses Sn+Ag+Cu (tin, silver, copper) solder. However, Sn+Cu (tin, copper), Sn+Zn+Bi (tin, zinc, bismuth) solder can also be used.

0.3mm X 100g	0.6mm X 100g	1.0mm X 100g

5 Receiver feature table

FEATURE/MODEL	CT-27C8G	CT-27L8G/UG/SG	CT-27G8G/UG
CHASSIS	BP404		AP404
MICRO	128K		
MENU LANGUAGE	ENG/SPAN/FR		
CLOSED CAPTION	X		
V-CHIP (USA/CANADA)	X		
CHANNEL COUNT	181		
REMOTE CONTROL	EUR7613Z10	EUR7713010	
CRT SUPPLIER	MDDA		
CHASSIS	NA10		
COMB FILTER	DIGITAL		
V/A NORM (X=BOTH)	V		
MTS/SAP/DBX	X		
BUILT-IN AUDIO POWER	1.5Wx2 (10%)		
No. OF SPEAKERS	2		
AI SOUND	X		
A/V IN (REAR/FRONT)	2(2/1)		
COMPONENT INPUT (Y, Pb, Pr)	1	---	
S-VIDEO INPUT (REAR/FRONT)	1/0		
DIMENSIONS (WxDxH)	754.3x534.3x601.6mm 29.69x21.03x23.68in	665.2x544.5x594.8mm 26.18x21.43x23.41in	665.2x544.5x594.8mm 26.18x21.43x23.41in
WEIGHT (Kg/Lbs)	35.4/78.04	34.5/76.05	34.5/76.05
VIDEO INPUT JACK	1Vp-p 75Ω, phono jack		
AUDIO INPUT JACK	500mV RMS 47kΩ		
HEADPHONE JACK	X		

Note:

Specifications are subject to change without notice or obligation. Dimensions and weights are approximate.

6 Board description table

CT-27G8G / CT-27G8UG

BOARD	PART NUMBER	DESCRIPTION
A	TNP2AH047GA	MAIN BOARD
C	TNP2AA122GA	CRT BOARD

CT-27L8G / CT-27L8UG / CT-27L8SG / CT-27C8G

BOARD	PART NUMBER	DESCRIPTION
A	TNP2AH047GB	MAIN BOARD
C	TNP2AA122GA	CRT BOARD

NOTE

When ordering a replacement board assembly, append an "S" to the board number

EXAMPLE

To order the A Board, for CT-27G8G the replacement board is TNP2AH047GAS.

7 TV Location of controls

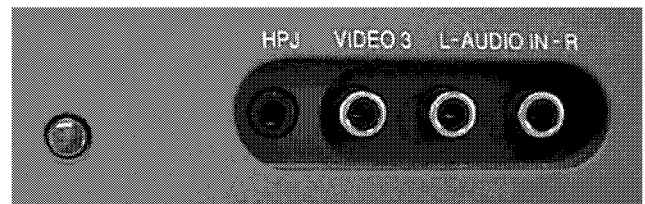
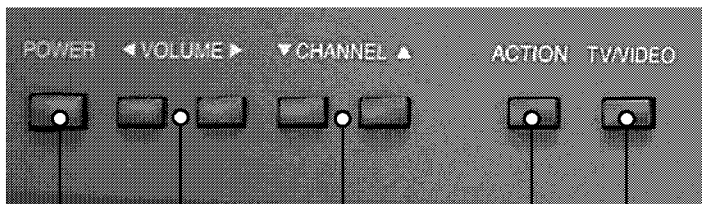

IR Sensor
& Front AV jacks

Quick reference control operation

- 1 **Power** - Press to turn ON or OFF.
- 2 **Volume** - Press to adjust sound level, or to adjust audio menus, video menus, and select operating features when menus are displayed
- 3 **Channel** - Press to select programmed channels. Press to highlight desired features when menus are displayed. Also use to select cable converter box channels after programming remote control infra-red codes (the TV/AUX/CABLE switch must be set in CABLE position).
- 4 **Action** - Press to display main menu and access on screen feature and adjustment menus.
- 5 **TV/Video** - Press to select TV or one of the video inputs, for the main picture or the PIP frame (when PIP frame is displayed).

8 Location of controls (remote)

8.1. EUR7713010

POWER

Press to turn ON and OFF.

VOL

Press to adjust TV sound and navigate in menus.

MUTE

Press to mute sound.

KEYBOARD

Press to select any channel.

R-TUNE

Press to switch to previously viewed channel or video mode.



SAP

Press to access the secondary audio program broadcast.

CH

Press to select next or previous channel and navigate in menus.

TV/VIDEO

Press to select TV, Video mode.

RECALL

Press to display time, channel sleep timer and other options.

Note:

For additional information about this remote please refer to the owner's manual section remote operation, listed on the parts list section.

8.2. EUR7613Z10

POWER

Press to turn ON and OFF.

TV - VCR - DBS/CBL - DVD

Press to select a component.

MUTE

Press to mute sound.

TV/VIDEO

Press to select TV, Video mode.

MENU

Press to select TV, Video mode.

KEYBOARD

Press to select any channel.

R-TUNE

Press to switch to previously viewed channel or video mode.



SAP

Press to access the secondary audio program broadcast.

CH

Press to select next or previous channel and navigate in menus.

VOL

Press to adjust TV sound and navigate in menus.

RECALL

Press to display time, channel sleep timer and other options.

GUIDE

DBS and DVD functions button.

EXIT

DBS menu function button.

PROG

Press for delimiter between major and minor channel number.

Note:

For additional information about this remote please refer to the owner's manual section remote operation, listed on the parts list section.

9 Dissassembly for service

Back cover

Remove all the screws marked with an arrow (←) from the back of the receiver

NOTE

Screw configuration, type, and number of screws vary depending on the model of the receiver serviced and the application; various models are covered in this manual. Use same hardware when reassembling the receiver.

- 3 screws at the top edge of the receiver.
- 1 screw by the A/V jacks.
- 1 screw at each lower corner of the receiver.
- 1 screw by the Flyback.
- 1 screw by the AC cord (only in CT-27C8G models).

A-Board - Main chassis

1. Slide the chassis completely out of the guide rails.
2. Stand the receiver on its edge. The underside of the board is completely accessible for component replacement.

Note:

Some tie-wraps that secure the wire dressings may need to be unfastened for chassis removal.

C-Board - CRT output

The board plugs onto the socket on the CRT neck. To release the Focus wire, use a dull object to release the tab on the socket (near the wire opening) and carefully pull on the wire. To connect the focus wire, press on the tab to lock it then insert the wire in the opening and press on it until it is fully inserted and locked in place.

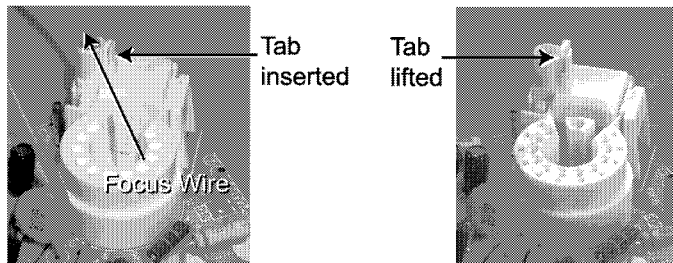

Focus cable release

Speakers

Each speaker is secured to the cabinet with 4 screws.

NOTE

When reassembling speakers be sure to connect the speaker wires to the correct speaker lead (+) (-)

9.1. Disassembly for CRT replacement

1. Discharge the CRT as instructed in the "safety precautions".
2. Disconnect the yoke (DY) plug, degaussing coil (DEG) plug from the main board.
3. Unplug the CRT 2nd anode button from the main board.
4. Remove the C-Board from the CRT base and unplug the black wires (CRT dag ground) C10 & C11.
5. Disconnect the speakers plug from the A-Board.
6. Lift the main chassis (A-Board) and all mounted boards completely out with the CRT board attached.
7. Perform complete removal of chassis, as instructed in "disassembly for service" section.

CRT replacement

1. Perform "disassembly for CRT replacement" procedure.
2. Insure that the CRT H.V. Anode button is discharged before handling the CRT. Read the "safety precautions" section on handling the picture tube.
3. Remove the components from the CRT neck and place the cabinet face down on a soft pad.
4. Note the original order for the CRT mounting hardware as they are remove from the CRT mounting brackets at each corner of the CRT.
5. Remove the CRT with the degaussing coil and the dag ground braid attached.
6. Note the original locations and mounting of the degaussing coil and the dag ground assembly to insure proper reinstallation on the replacement CRT.

To remove and remount the degaussing coil:

- Unhook the coil spring from the bottom corners of the CRT ears.
 - Release the braid loop from the upper corners of the CRT ears.
7. Mount the dag ground braid on the replacement CRT. Position the degaussing coil with new ties. Dress coil as was on the original CRT.
 8. Replace the components on CRT neck and reinstall into cabinet. Verify that all ground wires and circuit board plugs get connected.

IMPORTANT NOTICE

When ordering the CRT, please order CRT and CRT kit also. Please see parts list section for part numbers.

9.2. Back Cover Removal

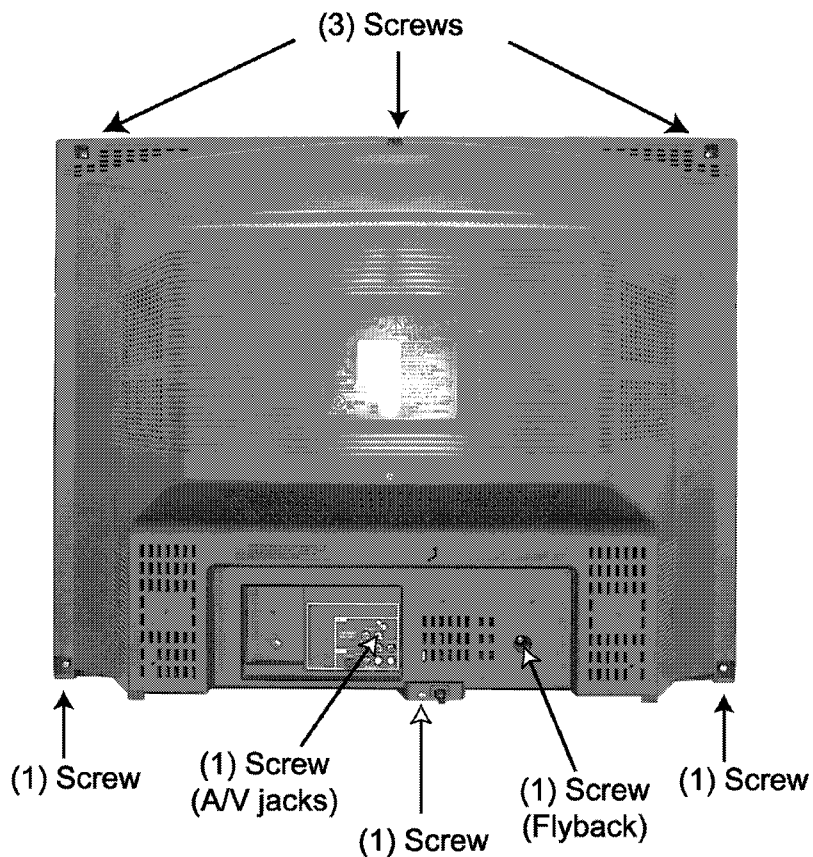

Back Cover (CT-27C8G).

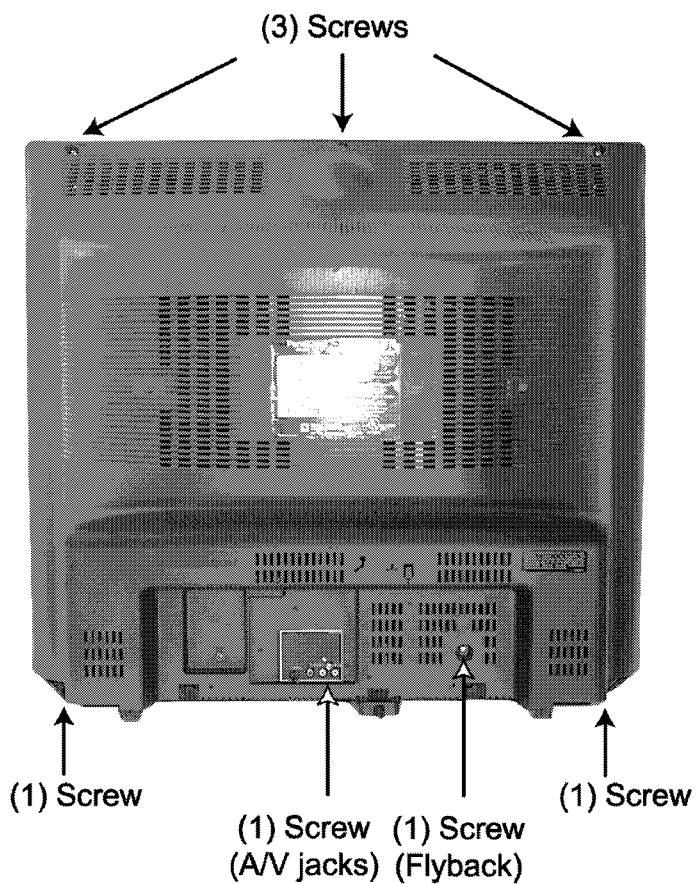

Back Cover (CT-27L8G/UG/SG, CT-27G8G/UG)

10 Chassis service adjustment procedures

All service adjustments are factory preset and should not require adjustment unless controls and/or associated components are replaced.

Note:

Connect the (-) lead of the voltmeter to the appropriate ground. Use IC801's heat sink when the HOT ground symbol is used. Otherwise, use COLD ground (Tuner shield, IC451's heat sink or FA2).

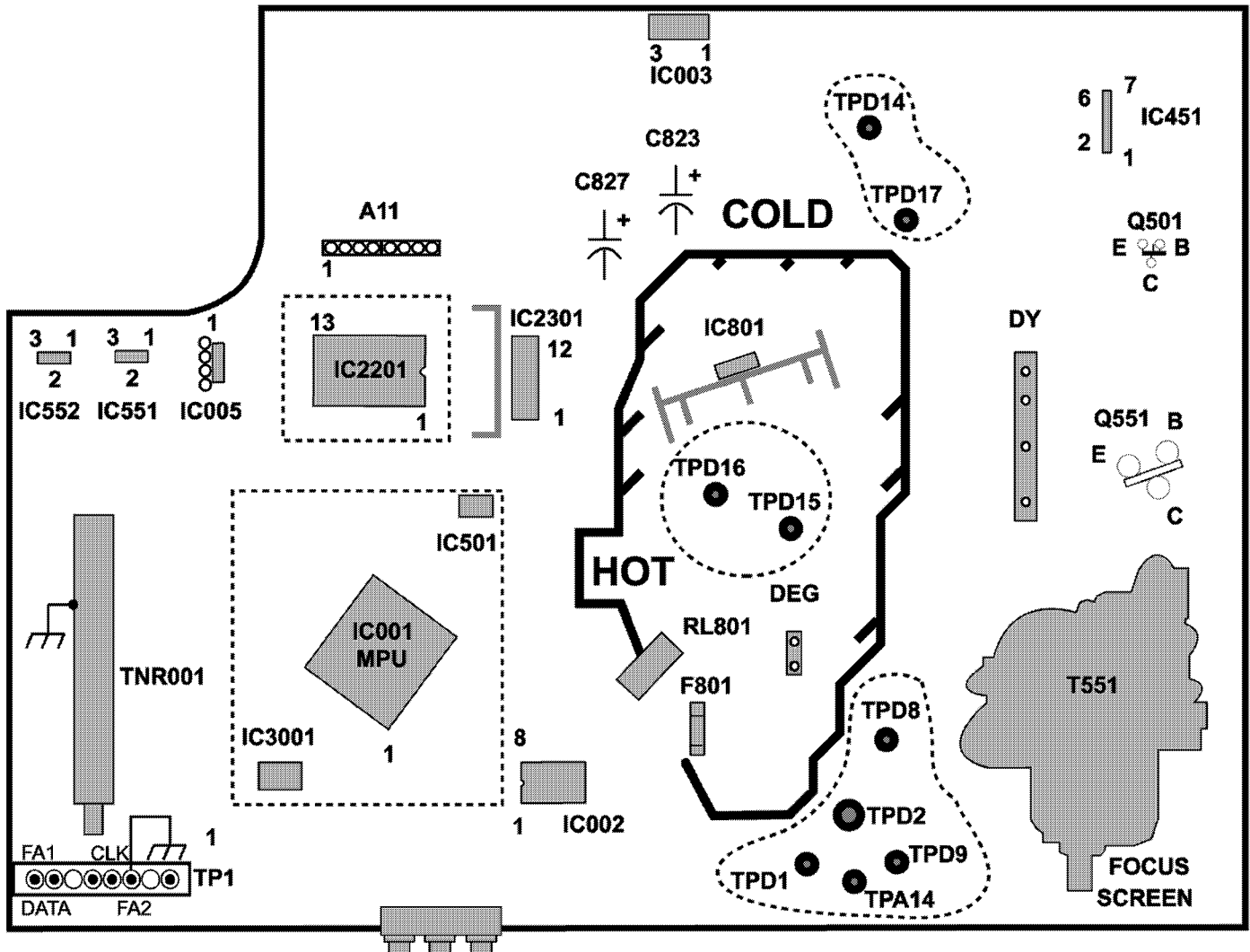

Component and Voltage Test Points

Note:

Components and test points within dotted areas are located on trace side.

B+ voltage check

1. Set the BRIGHT and PICTURE to minimum by using the PICTURE menu.
2. Connect the DVM between C825 (+ side) or TPD14 and cold ground.
3. Confirm that B+ voltage is $131.0V \pm 2.0V$. This voltage supplies B+ to the horizontal output and flyback circuits.

Source voltage chart

120V AC line input. Set the BRIGHT and the PICTURE to minimum by using the PICTURE menu. Use cold or hot ground for the (-) lead of the DVM as needed.

A-BOARD	TEST POINT	VOLTAGE
+B2	TPD14	$131.0 \pm 2.0V$
SOUND	C823 (+)	$18.1 \pm 1.0V$

A-BOARD	TEST POINT	VOLTAGE
STB12V	C827 (+)	$12.8 \pm 1.0 V$
220V	TPA14	$217 \pm 10 V$
VERTICAL	TPD8	$27.4 \pm 1.5V$
9V	IC551 pin 3	$9.0 \pm 0.5V$
5V	IC552 pin 3	$5.0 \pm 0.5V$
3.3V	IC005 pin 2	$3.3 \pm 0.3V$
EHT	CRT anode	$29.25 \pm 1.25kV$
HEATER	JK351 H-HGND	$6.0 \pm 0.24V$

High voltage check

1. Select an active TV channel and confirm that horizontal is in sync.
2. Adjust BRIGHTNESS and CONTRAST using PICTURE icon menu so video just disappears.
3. Using a high voltage meter confirm that the high voltage is $29.25 \pm 1.25kV$.

11 Service mode (electronic adjustments)

This receiver has electronic technology using the IC bus concept. It performs as a control function and it replaces many mechanical controls. Instead of adjusting mechanical controls individually, many of the control functions are now performed by using "on screen display menu". (The service adjustment mode).

NOTE

It is suggested that the technician reads all the way through and understand the following procedure for entering/exiting the service adjustment mode; then proceed with the instructions working with the receiver. When becoming familiar with the procedure, the flow chart for service mode may be used as a quick guide.

Quick entry to service mode

When minor adjustments need to be done to the electronic controls, the method of entering the service mode without removal of the cabinet back is as follows using the remote control:

1. Select SET-UP icon and select CABLE mode.
2. Select TIMER icon and set SLEEP time for 30 Min.
3. Press "ACTION" twice to exit menus.
4. Tune to the channel 124.
5. Adjust VOLUME to minimum (0).
6. Press VOL → (decrease) on receiver. Red "CHK" appears in upper corner.

To toggle between aging and service modes:

While the "CHK" is displayed on the left top corner of the CRT, pressing "ACTION" and "VOL" UP on the TV simultaneously will toggle between the modes. Red "CHK" for service and yellow "CHK" for aging.

7. Press POWER on the remote control to display the service adjustment modes menu, select adjustment by pressing the volume right/left buttons and channel up/down buttons on the remote and ACTION to enter the adjustment.

MTS	MTSIN	SEPAL	SEPAH	
CLOCK	CLOCK			HHSTH
VIDEO	COLOR	TINT	BRIGH	CONT
	B-Y_G	CUT_G	CUT_R	CUT_B
	BRT	R-DR	B-DR	
HDEF	H POS			
VDEF	VEAMP	V-C	V-S	VPOS
SETID	ID1	ID2	ID3	

Exiting the service mode:

This TV goes out from service mode when it is unplugged or turned OFF. To exit the service mode, turn the TV OFF from or unplug the TV from A.C.

Other method

Press ACTION and POWER on the receiver simultaneously for at least 2 seconds.

The receiver momentarily shuts off; then comes back on tuned to channel 3 with a preset level of sound.

Any programmed channels, channels caption data and

some others user defined settings will be erased when exited by pressing ACTION and POWER on receiver.

IMPORTANT NOTE

Always check that the TV exits the service mode.

To confirm colors

When in service mode (red "CHK" is displayed) press RECALL on the remote control to enter the purity field check mode

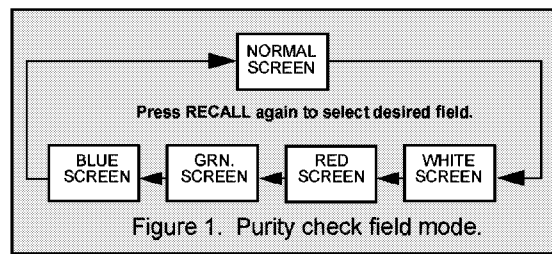

Figure 1. Purity check field mode.

Entering service mode (open-back method)

While the receiver is connected and operating in normal mode, momentarily short test point FA1 (TP1 pin 2) to cold ground (TP1 pin 3).

The receiver enters the aging mode.

Yellow letters "CHK" appear in the upper left corner of the screen.

(The volume right/left and channel up/down will adjust rapidly).

Note:

If service mode is accessed by this method be sure to reset the set after service is performed.

11.1. Service adjustment default values for items

NAME	DESCRIPTION	REGISTER VALUE		
		CT-27C8G	CT-27G8G/UG	CT-27L8G/UG/SG
MTSIN	MTS INPUT LEVEL		17	
SEPAL	MTS LOW LEVEL SEPARATION		08	
SEPAH	MTS HIGH LEVEL SEPARATION		1D	
CLOCK	CLOCK		128	
HHSTH	HHS VOLTAGE LEVEL REFERENCE		8C	
COLOR	COLOR		15	
TINT	TINT		56	
BRIGH	SUB-BRIGHTNESS		4E	
CONT	SUB-CONTRAST		60	
B-Y_G	MAGENTA TINT ADJ		80	
CUT_G	GREEN CUT-OFF		C3	
CUT_R	RED CUT-OFF		0E	
CUT_B	BLUE CUT-OFF		5B	
BRT	BRIGHT		4E	
R-DR	RED DRIVE		00	
B-DR	BLUE DRIVE		00	
H-POS	HORIZONTAL POSITION		70	
VEAMP	VERTICAL SIZE		AA	
V-C	VERTICAL LINEARITY		4C	
V-S	VERTICAL SIZE CORRECTION		00	
VPOS	VERTICAL POSITION		7C	
ID1*	ID SWITCH 1	F0	88	F0
ID2*	ID SWITCH 2	06	06	06
ID3*	ID SWITCH 3	30	30	30

IMPORTANT:

These table values are approximated and could change due to variation of electrical characteristics in each set, except for the ID switch values.

*Note:

The correspondent ID switch (ID1, ID2, ID3) data configuration should not be modified in any way. If EEPROM circuit needs to be replaced, these ID values should be configured according with this table.

12 Service adjustments (electronic controls)

NOTE

Please correlate with available pattern on all adjustments

12.1. Sub-Brightness and Contrast Service DAC adjustment (BRIGH, CONT)

Adjustment of this control is important for setting proper operation of customer brightness and picture controls. Do not adjust the SCREEN VR after the sub-brightness is set.

This adjustment is factory set. Do not adjust unless repairs are made to associated circuit, the CRT Board or when the CRT is replaced.

Preparation

1. Apply a colorbar pattern.
2. Set the PICTURE control to the maximum.
3. Set COLOR control to minimum (no color on picture).
4. Set the BRIGHTNESS control to the center.
5. Set the SHARPNESS control to the center.
6. Connect the oscilloscope to TP35.

Procedure

1. In the service mode, select DAC for brightness adjustment "BRIGH", and adjust data to obtain $3.6 \pm 0.1V$ between 7.5IRE and GND level at TP35. (See waveform detail).
2. In service mode, select DAC for contrast adjustment "CONT", and adjust data to obtain between 7.5IRE and 100IRE level at TP35. (See waveform detail)

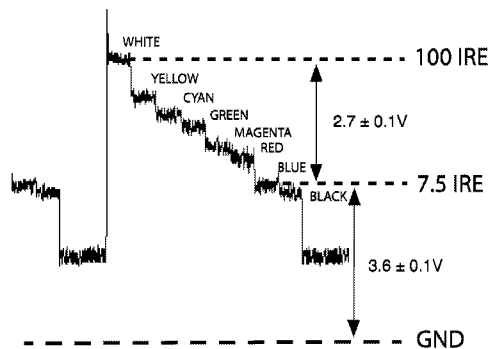

12.2. Color output adjustment Service DAC adjustment (COLOR, TINT)

NOTE

if a rainbow pattern generator is available perform the following procedure; the next section describes the procedure with no rainbow pattern.

Make sure that sub-contrast adjustment was finished prior to perform this adjustment.

PREPARATION

1. Normalize the picture settings.
2. Set the BRIGHTNESS control to minimum.

3. Set the COLOR control to the center.
4. Set the TINT control to the center.
5. Set the PICTURE control to the maximum.
6. Set the SHARPNESS control to the minimum.

PROCEDURE

1. Apply a rainbow color bar pattern.
2. Connect the oscilloscope to TP37.
3. In service mode adjust "TINT" register until the waveform measured is as the one shown. Tint level from A and B peaks must be almost in the same level (0.35 Vp).

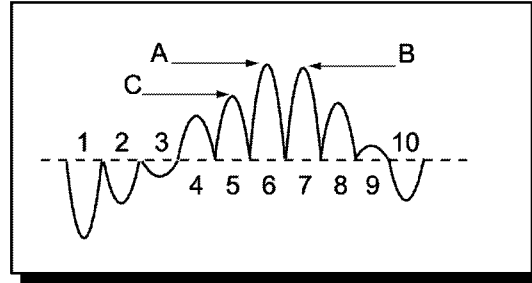

TP37 Waveform.

4. Connect the oscilloscope to TP35 and GND.
5. Adjust "COLOR" register so that the amplitude is $0.9 \pm 0.05Vp-p$.

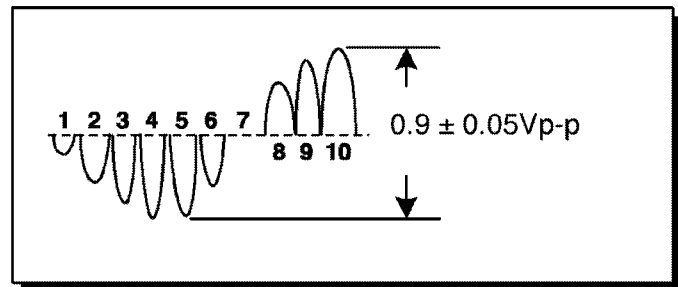

TP35 Waveform.

12.3. Color output adjustment Service DAC adjustment (COLOR, TINT, B-Y_G)

NOTE

Color and tint adjustment sets the reference settings for the user controls; It is important to read the procedures.

(NO RAINBOW PATTERN)

Make sure that sub-contrast adjustment was finished prior to perform this adjustment

PREPARATION

Normalize the picture settings.

PROCEDURE

1. Apply a color bar pattern.
2. In service mode adjust "R DR" and "B DR" data to "80".
3. In service mode adjust "TINT" data so that the color does not become greenish or redish.
4. In service mode adjust "COLOR" data so that the color

level is not too high (saturated) or too low (tending to black and white).

5. In service mode adjust "B-Y G" data so that blue and green seem natural.
6. Confirm that saturation and picture are normal (normal image).
7. If image is not satisfactory, repeat adjustment until the image is normal and natural.

NOTE

The image can be compared against other set to see the image quality.

12.4. Color temperature adjustment (B/W Tracking) Service DAC Adjust. (CUT R) (CUT G) (CUT B) (R DR) (B DR)

Minor Touch-Up Method

OBSERVE low and high brightness areas of a B/W picture for proper tracking. Adjust only as required for "good gray scale and warm highlights".

1. LOW LIGHT areas - In service mode for making electronic adjustments, select CUT R, CUT G, CUT B and adjust the picture for gray.
2. HIGH LIGHT areas - In service mode for making electronic adjustments, select drive R DR, B DR and adjust the picture for warm whites.

Complete adjustment

PREPARATION

1. Turn the receiver "ON" and allow 30 minutes warm up at WHITE PATTERN.
2. Apply a color bar pattern (with no color).
3. Turn the SCREEN control (part of FBT T551) fully counterclockwise.
4. Preset the following service DACs for best results:
 - BRIGH _____ 1 D0
 - CUT R _____ 02 00
 - CUT G _____ 02 00
 - CUT B _____ 02 00
 - R DR _____ 07 FF
 - B DR _____ 07 FF

PROCEDURE

1. Connect the oscilloscope to KG (CRT-Board).
2. In service mode for making electronic adjustment, select "BRIGH" DAC.
3. Press RECALL button on the remote control to collapse the raster. (service SW).
4. Connect oscilloscope to KG on C-Board and adjust service mode "CUT-G" DAC until $195 \pm 2V$ above DC ground is measured
5. Remove the probe from KG.
6. Turn screen clockwise slowly until color is slightly appeared.
7. Then adjust "CUT R" and "CUT B" until line becomes

white.

8. Press RECALL button on the remote to restore the raster.
9. Adjust "R DR" and "B DR" so the white seems like white and black like black.
10. Apply a normal signal and confirm that the image is normal and a good gray scale
11. If correction is needed perform minor touch-up method.

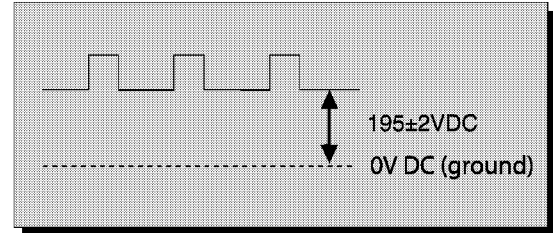

12.5. Deflection adjustments

To reset deflection adjustments

To reset deflection adjustments to factory adjusted default, enter to service mode (with red CHK displayed), press POWER button on remote to display the service menu, then press and hold RECALL button for at least three seconds, a reset message will appear in the image.

Use this feature when deflection adjustment gets off adjustment to the point that it cannot be adjusted back easily.

12.5.1. H-Center adjustment

PREPARATION

1. Apply a crosshatch pattern.
2. Normalize the picture settings.

PROCEDURE

1. Apply a monoscope pattern to center the picture.

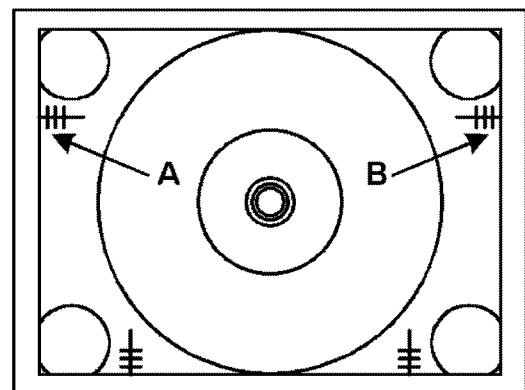

Horizontal Center Adjustment

2. If the horizontal center is not aligned, in service mode adjust "H POS" DATA to adjust the horizontal center of the monoscope pattern to the CRT center.
3. Verify that horizontal width (A & B mark) is within 4.5 ± 0.7 .

12.5.2. Vertical linearity(V-C), V-Size and V-Position adjustment

PREPARATION

1. Apply a crosshatch pattern
2. Normalize the picture settings.

PROCEDURE

1. Enter service mode, select DAC adjustment "V-POS" and adjust monoscope pattern to the center vertical position of the CRT center mark.
2. Adjust linearity data "V-C" so that interval of "a" is same as "b" (a=b).

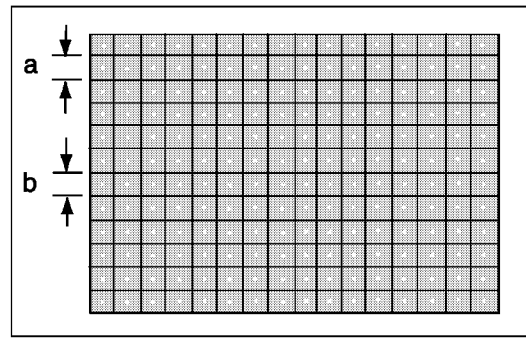
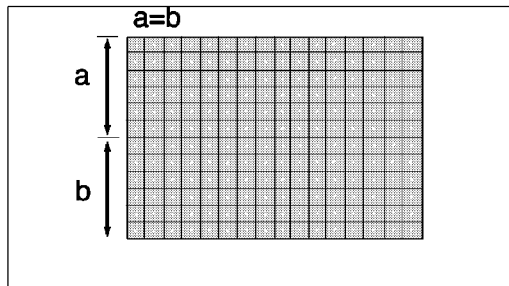

V-Adjustment

3. If the v-position is not at the CRT center, adjust V position "V POS" DATA again.
4. Apply a monoscope pattern.
5. Confirm that center horizontal line is in center mark on CRT.
6. Adjust "VEAMP" register for correct vertical size by making monoscope round circle leaving 4 marks off the CRT edge.

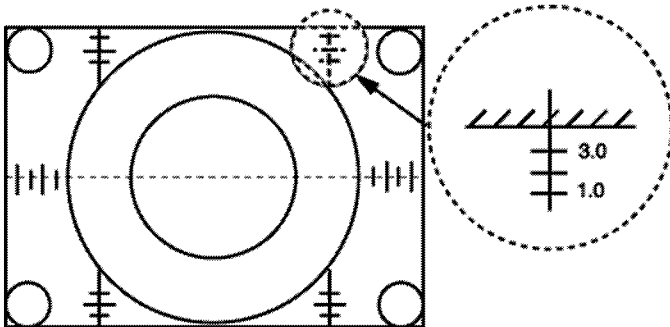

Vertical centering adjustment.

12.5.3. V-S Correction adjustment

PREPARATION

1. Apply a crosshatch pattern
2. Normalize the picture settings.

PROCEDURE

1. Enter to service mode
2. Check a and b sizes, If $b-a < -1.5\text{mm}$ (in top & bottom extending case)

- Increase "V-S" DATA by one step

NOTE

Repeat "a" and "b" until $b-a \pm 1.5\text{mm}$

3. Confirm to make outermost circle of monoscope pattern a correct circle

13 Identification of Components

13.1. Chassis Components

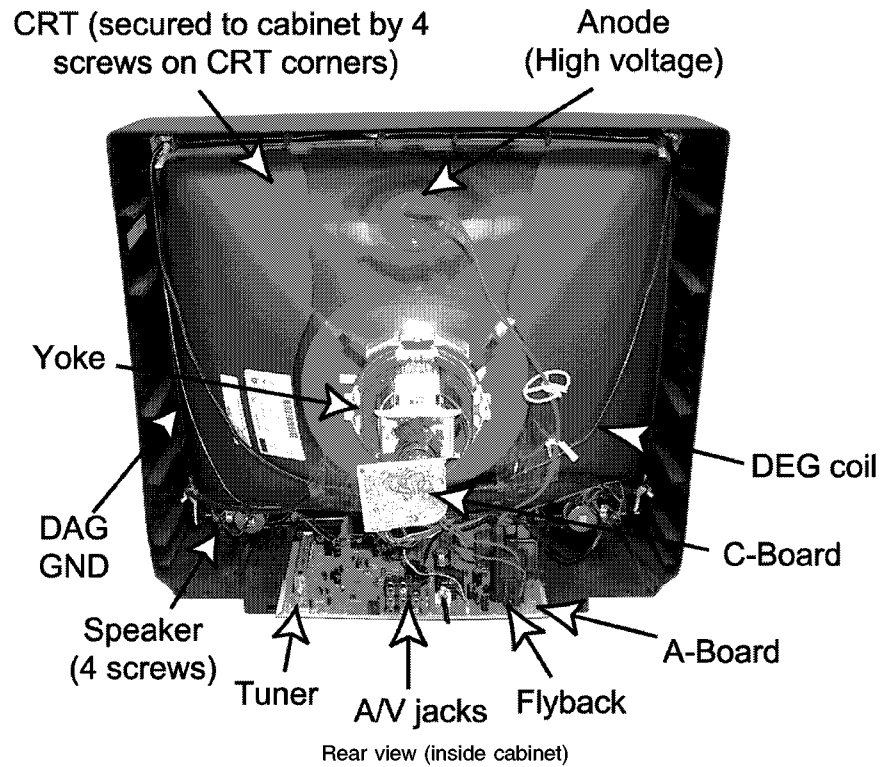

13.1.1. C-Board Chassis

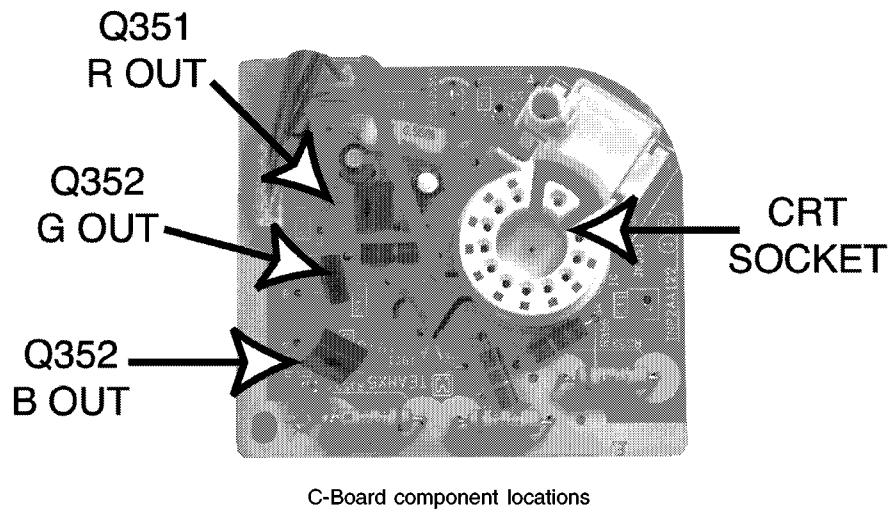

13.1.2. A-Board Chassis

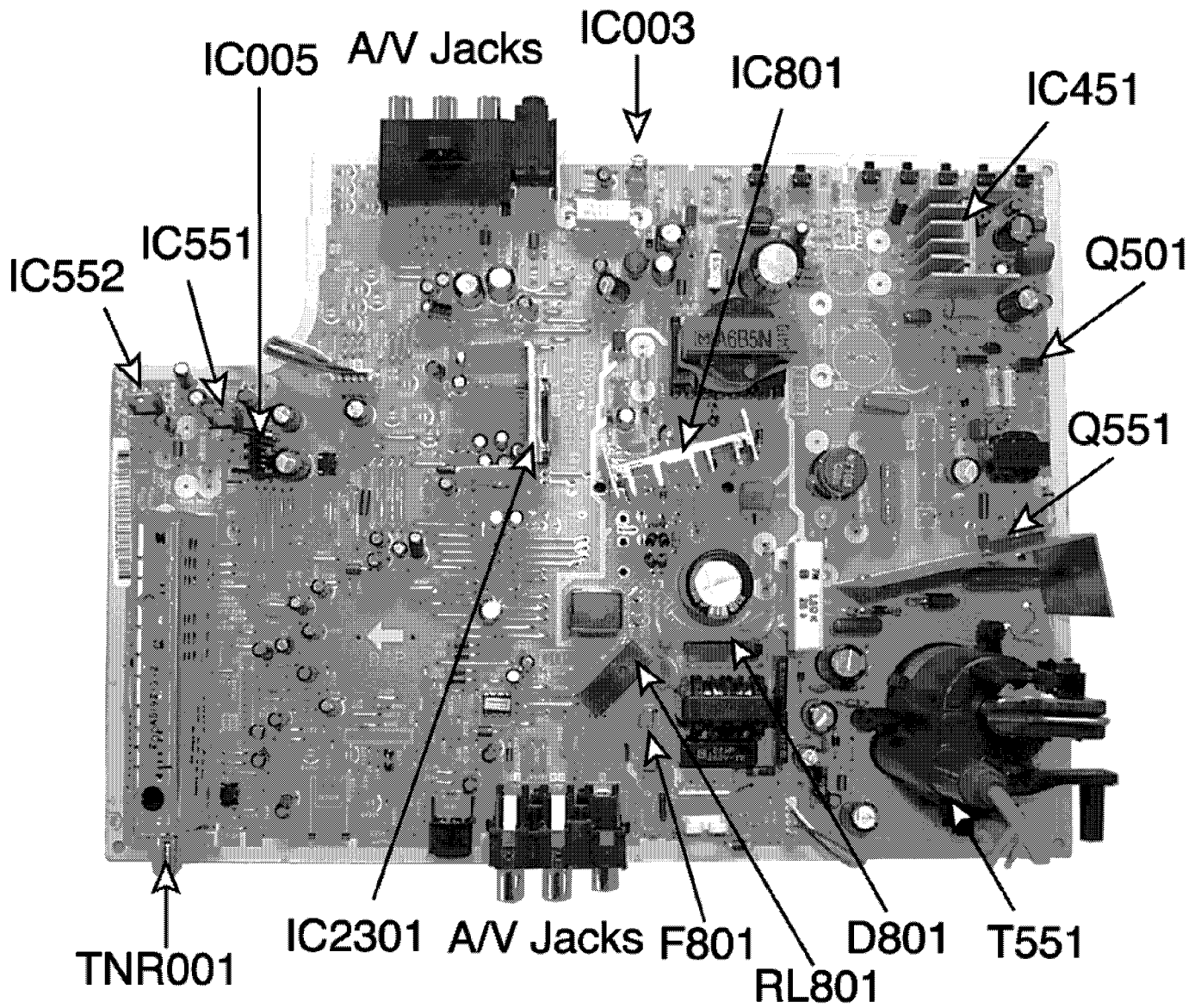

A-Board chassis (Top view)

13.1.3. A-Board Surface-mounted components

IC2201

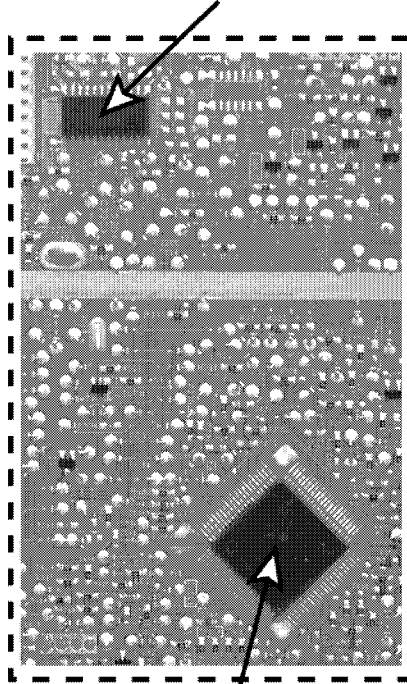

IC001

A-Board (bottom view)

14 Reference for PDF Colors

DESCRIPTION OF PDF LINK COLORS	
TYPE	DESTINATION
SCHEMATIC	
YELLOW ON IC	IC ON PCB
YELLOW ON CONNECTOR	CONNECTOR ON PCB
YELLOW ON SCHEMATIC	PCB
CYAN	WAVEFORM
GREEN ON SIDE	SCHEMATIC CONTINUED
GREEN ON CONNECTOR	CONNECTOR CONNECTION
BLUE ON IC	VOLTAGE
PCB	
BLUE ON IC	IC ON SCHEMATIC
BLUE ON CONNECTOR	CONNECTOR ON SCHEMATIC
BLUE ON PCB	SCHEMATIC
GREEN ON SIDE	PCB CONTINUED
BLOCK DIAGRAMS	
GREEN ON IC	IC ON SCHEMATIC
GREEN ON SIDE	BLOCK DIAGRAM CONTINUED

15 Conductor Views

15.1. A-Board Printed Circuit (Left Side)

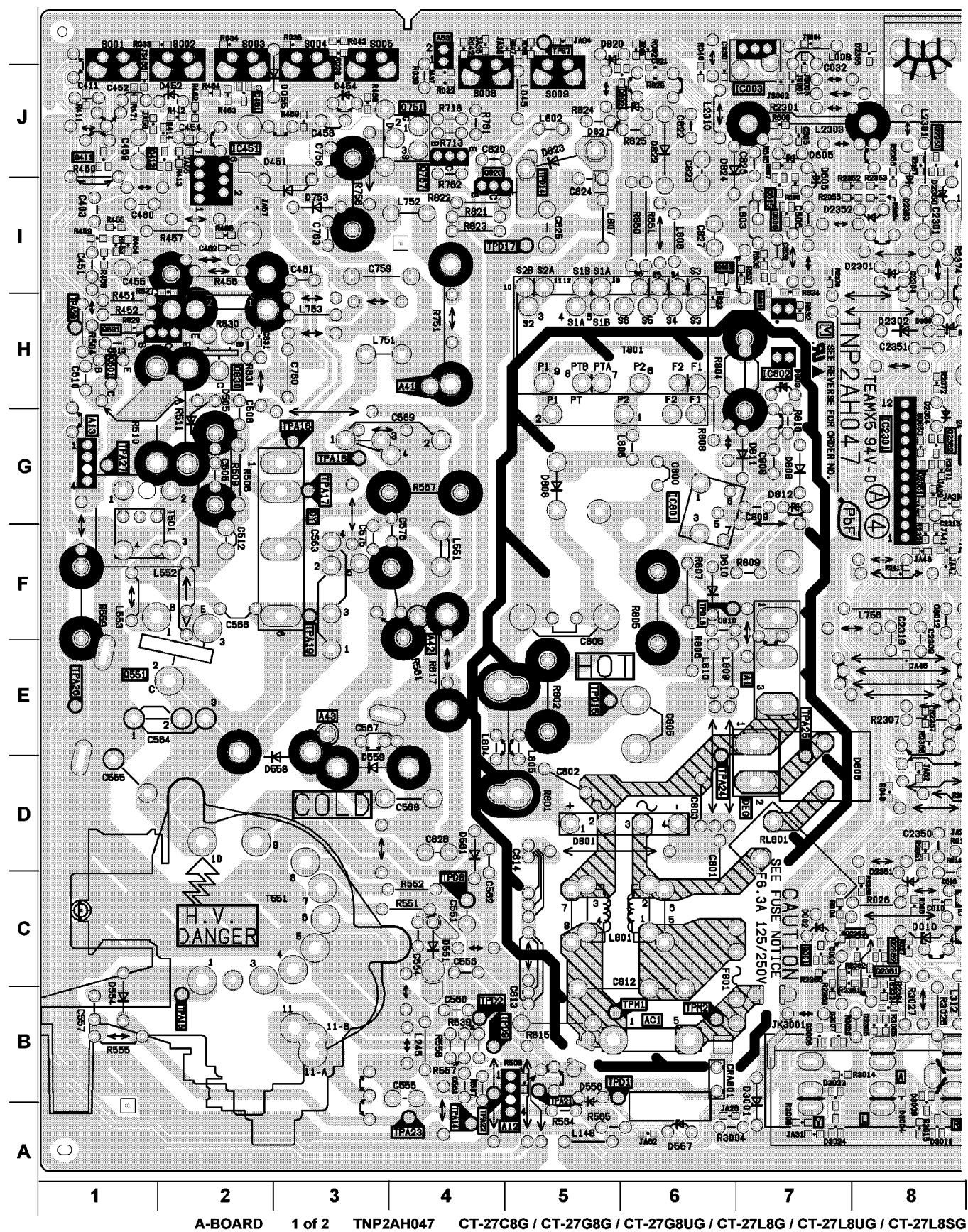

A-BOARD 1 of 2 TNP2AH047 CT-27C8G / CT-27G8G / CT-27G8UG / CT-27L8G / CT-27L8UG / CT-27L8SG

15.2. A-Board & C Board Printed Circuit (Right Side)

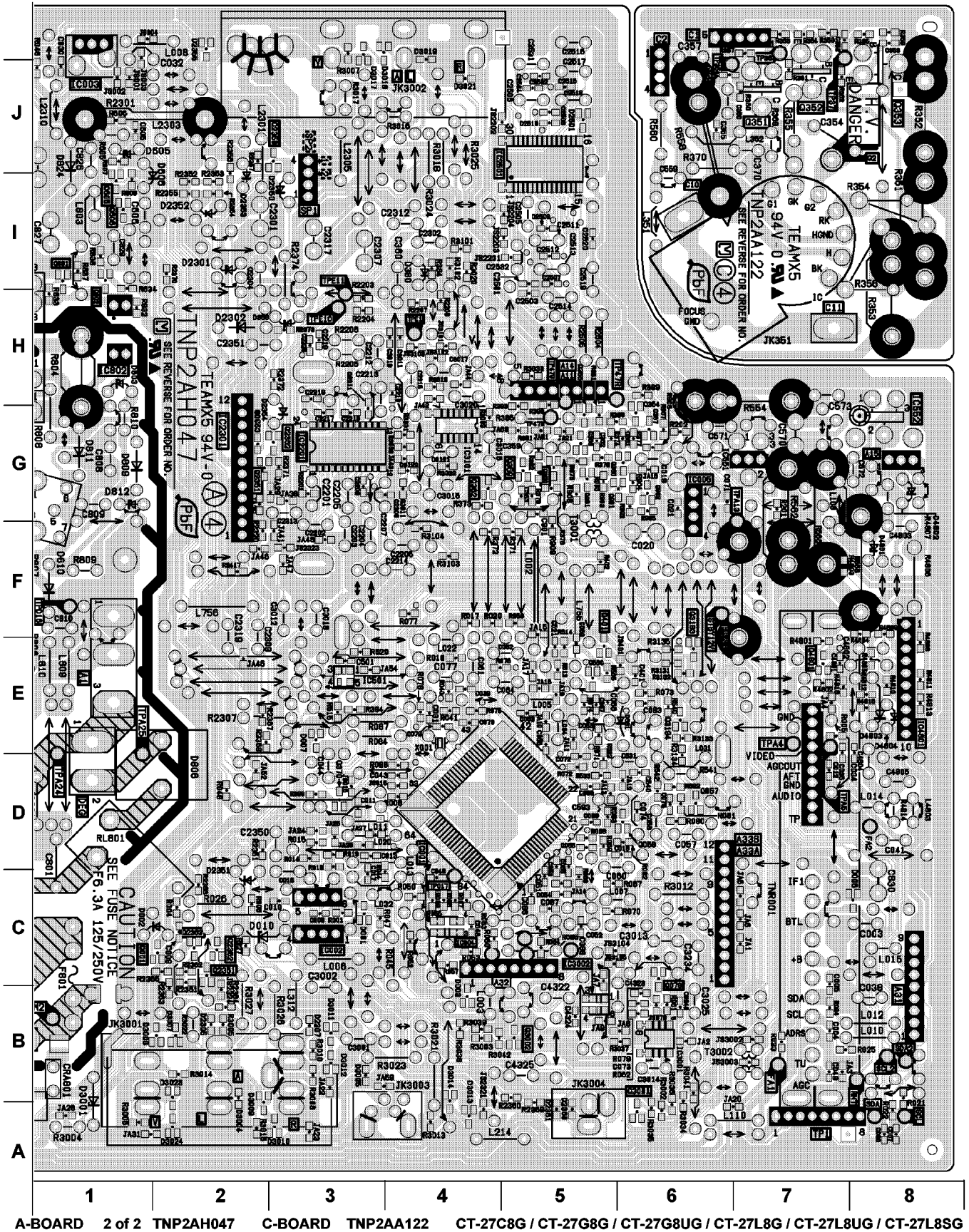

16 Block Diagrams

16.1. Video Signal Block Diagram

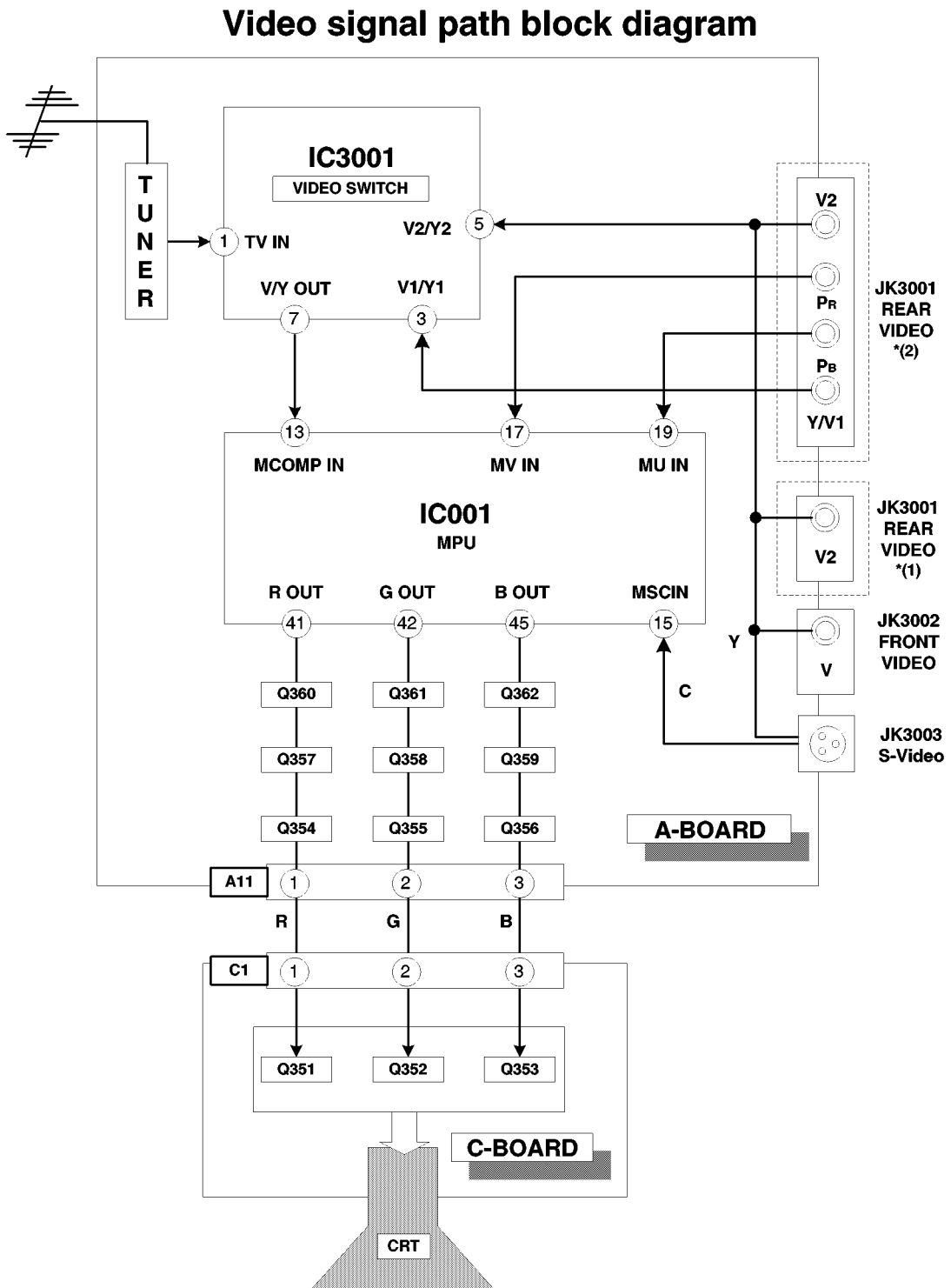

*(1) CT-27G8G / CT-27G8UG

*(2) CT-27C8G / CT-27L8G / CT-27L8UG / CT-27L8SG

16.2. Audio Signal Block Diagram

Audio signal path block diagram

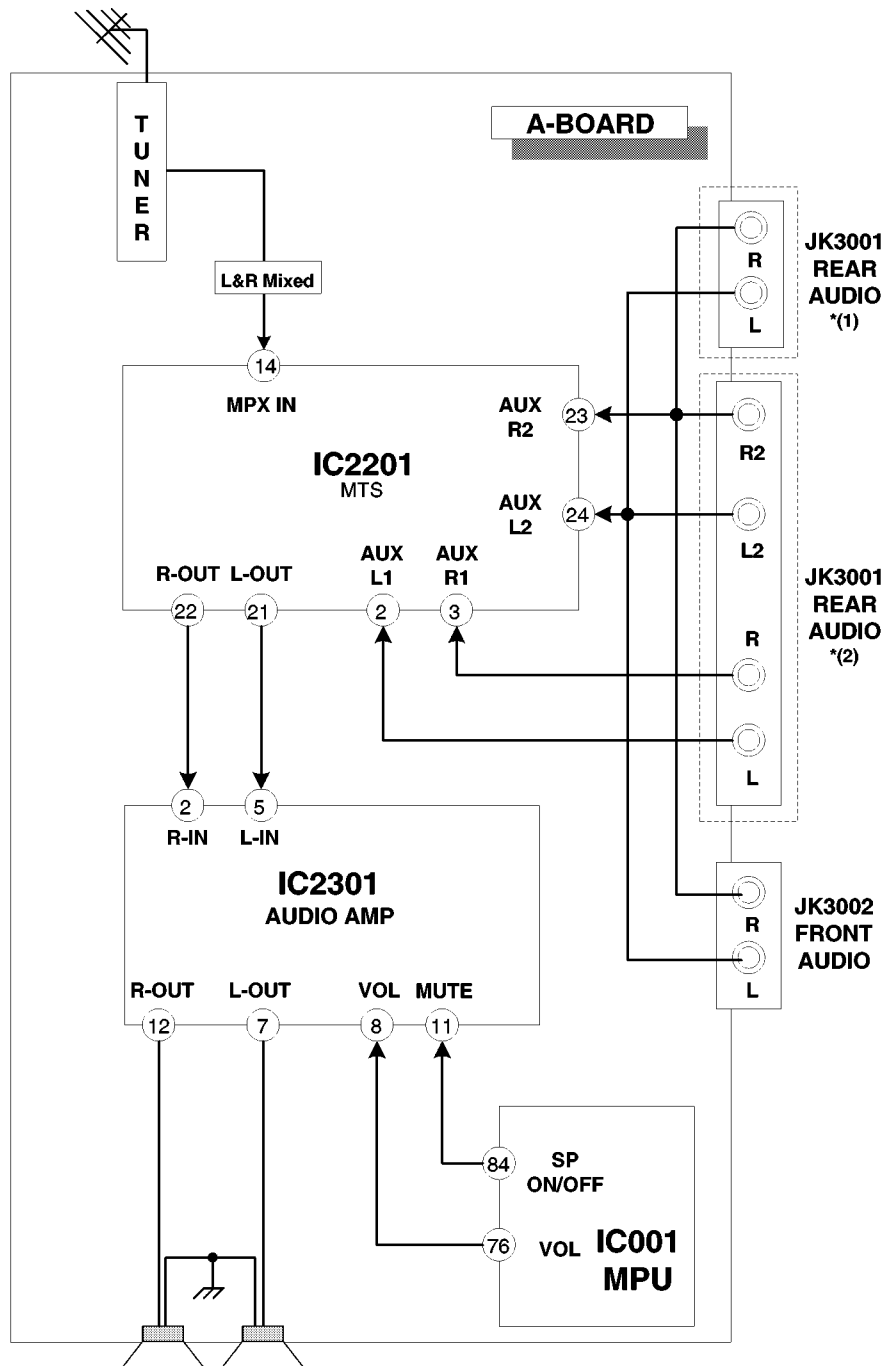

*(1) CT-27G8G / CT-27G8UG

*(2) CT-27C8G / CT-27L8G / CT-27L8UG / CT-27L8SG

17 Schematics

17.1. English Schematic Notes

Notes:

IMPORTANT SAFETY NOTICE

THIS SCHEMATIC DIAGRAM INCORPORATES SPECIAL FEATURES THAT ARE IMPORTANT FOR PROTECTION FROM X-RADIATION, FIRE AND ELECTRICAL SHOCK HAZARDS. WHEN SERVICING IT IS ESSENTIAL THAT ONLY MANUFACTURERS SPECIFIED PARTS BE USED FOR THE CRITICAL COMPONENTS DESIGNATED WITH A \triangle IN THE SCHEMATIC.

CHIP TRANSISTOR LEAD DESIGNATION

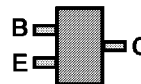

SCHEMATIC NOTES

- Resistors are carbon 1/4W unless noted otherwise.
 - Capacitors are ceramic 50V unless noted otherwise.
 - Coil value notes is inductance in μ H.
 - Test point indicated by \uparrow ; Test point but no pin \uparrow .
 - Components indicated with \triangle are critical parts and replacement should be made with manufacture specified replacement parts only.
 - (BOLD LINE) indicates the route of B+ supply.
 - The schematic diagrams are current at the time of printing and are subject to change without notice.
 - Ground symbol \downarrow indicates **HOT GROUND CONNECTION**; \uparrow indicates COLD GROUND.
- NOTE: All other component symbols are used for engineering design purposes.*

VOLTAGE MEASUREMENTS

- Voltage measurement:
 - AC input to the Receiver is 120V. NTSC (HD, 1125i & 525P when applicable) signal generator is connected to the antenna of the Receiver. (Color bar pattern of 100 IRE white and 7.5 IRE black.)
 - All Picture and Audio adjustments are set to Normalize.
TV ANT/CABLE - (Set-Up Menu) in TV/ANT Mode
Volume - Min.
TV/Video SW - TV position
Audio Mode - Stereo
 - Voltage readings are nominal and may vary $\pm 10\%$ on active devices. Some voltage reading will vary with signal strength and picture content.
 - Supply voltages are nominal.
 - Ground symbol \downarrow indicates ground lead connection of meter. Incorrect ground connection will result in erroneous readings.
- CAUTION: Incorrect ground connection of the test equipment will result in erroneous readings.**

WAVEFORM MEASUREMENTS

- $\textcircled{3}$ indicates waveform measurement. (Measurement can be taken at the best accessible location in common to the indicated point.)
 - Taken with an NTSC signal generator connected to the antenna terminal. (NTSC color bar pattern of 8 bars of EIA colors, 100 IRE white and 7.5 IRE black.)
 - Customer Controls (Picture/Audio Menu) are set to Normalize. Volume is set to "MIN".
 - All video and color waveforms are taken with a wideband scope and a probe with low capacitance (10 to 1). Shape and peak altitudes may vary depending on the type of Oscilloscope used and its settings.
 - Ground symbol \downarrow shown on waveform number indicates (Hot) ground lead connection of the Oscilloscope.
- CAUTION: Incorrect ground connection of the test equipment will result in erroneous readings.**

17.2. Notas de Esquemáticos en Español

Notas

NOTA DE SEGURIDAD

LOS DIAGRAMAS ELÉCTRICOS INCLUYEN CARACTERÍSTICAS ESPECIALES MUY IMPORTANTES PARA LA PROTECCIÓN CONTRA RAYOS-X, QUEMADURAS Y DESCARGAS ELÉCTRICAS. CUANDO SE DE SERVICIO ES IMPORTANTE USAR PARA REEMPLAZO DE COMPONENTES CRÍTICOS, SOLO PARTES ESPECIFICADAS POR EL FABRICANTES. LOS COMPONENTES CRÍTICOS ESTAN SEÑALADOS EN LOS DIAGRAMAS POR EL SIMBOLO \triangle .

IDENTIFICACIÓN DE TERMINALES PARA TRANSISTORES EN CHIP

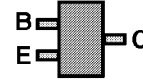

NOTAS DE LOS DIAGRAMAS

- Las Resistencias son de Carbón de 1/4W, a menos que se indique otra característica.
 - Los Capacitores son de Cerámica para 50V, a menos que se indique otra característica.
 - El valor indicado de las Bobinas es la inductancia expresada en μH .
 - Los puntos de prueba en la terminal de algún componente son indicados por \uparrow . Los puntos de prueba fuera de los componentes se indican con \uparrow .
 - Los componentes señalados con el símbolo \triangle son considerados componentes críticos y deben ser reemplazados sólo con las partes especificadas por el fabricante.
 - (LINEA GRUESA)** indica las líneas de alimentación de los Voltajes B+.
 - Los diagramas eléctricos están sujetos a cambio sin previo aviso.
 - El símbolo \downarrow indica que es una conexión a **Tierra Caliente** y el símbolo \nwarrow indica conexión a **Tierra Fría**.
- NOTA:** Los demás símbolos de componentes incluidos son usados con fines de diseño.

MEDICIÓN DE VOLTAJES

- Medición de voltaje:
 - El voltaje de entrada al Receptor es de 120V de Corriente Alterna. Un generador de patrones con formato NTSC se conecta a la entrada de la antena. (Patrón de Barras de Colores con 100 IREs para el Blanco y 7.5 IREs para el Negro.)
 - Los ajustes de los Menus Picture y Audio se normalizan. En el Menú Set-Up, en la opción ANTENA, se selecciona el modo de CABLE. El nivel de Volumen se minimiza. De los modos TV y Video, seleccionar el modo TV. Seleccionar modo Estereo del Audio.
 - Las mediciones de los voltajes son nominales y pueden variar hasta 10% en componentes en funcionamiento. Las lecturas de los voltajes pueden variar por la potencia de la señal y el contenido de la imagen.
 - Las fuentes de voltajes son nominales.
 - El símbolo \downarrow indica el tipo de tierra que se utiliza en la conexión del medidor.
- PRECAUCION:** Si no se utiliza la conexión a la tierra adecuada, se obtendrán mediciones equivocadas y podría dañar el equipo de medición.

MEDICIÓN DE FORMAS DE ONDA

- Un símbolo como $\textcircled{3}$ indica el punto para medir una señal. (La medición puede hacerse en el punto con mayor accesibilidad, siempre que sea común al indicado.)
 - Se midieron utilizando un generador con formato NTSC conectado a la terminal de la antena. (Patrón de 8 Barras de Colores EAI, formato NTSC de 100 IREs para el Blanco y 7.5 IREs para el Negro.)
 - Los ajustes de usuario de los Menus PICTURE y AUDIO se normalizaron. Posteriormente el nivel de volumen se ajusta al mínimo.
 - Las formas de onda de Video y Color fueron tomadas con un osciloscopio de banda alta y con un punta de prueba de baja capacitancia (10 a 1). La forma y amplitud de las ondas puede variar según el tipo de osciloscopio que se utilice y sus características.
 - El símbolo de tierra \downarrow que aparece junto al número de la forma de onda, indica que se utiliza conexión a **Tierra Caliente** en el extremo negativo de la punta de prueba.
- PRECAUCION:** Si no se utiliza la conexión a la tierra adecuada, se obtendrán mediciones equivocadas y podría dañar el equipo de medición.

17.3. A-Board Schematic TNP2AH047GA/GB (page 1 of 4)

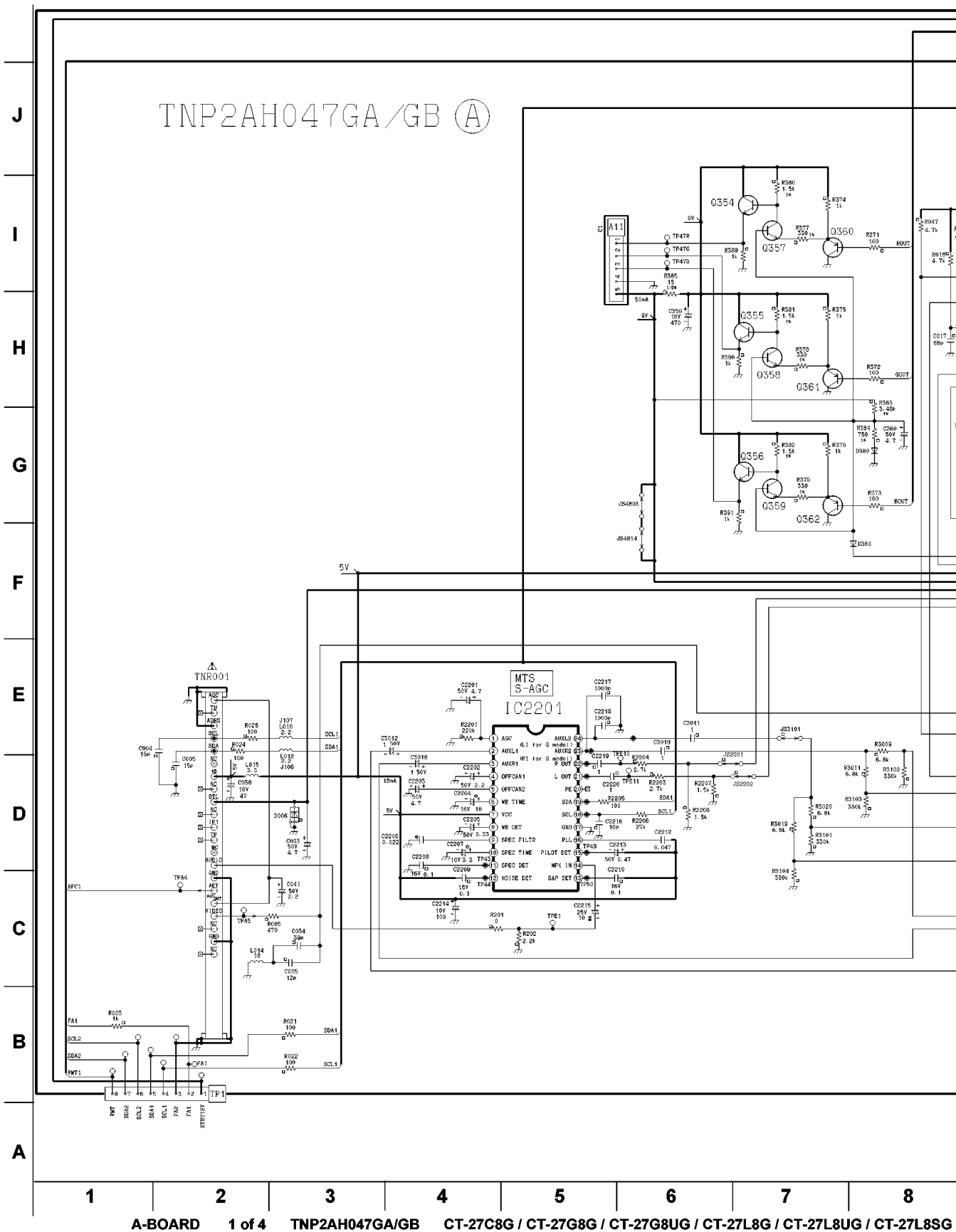

17.4. A-Board Schematic TNP2AH047GA/GB (page 2 of 4)

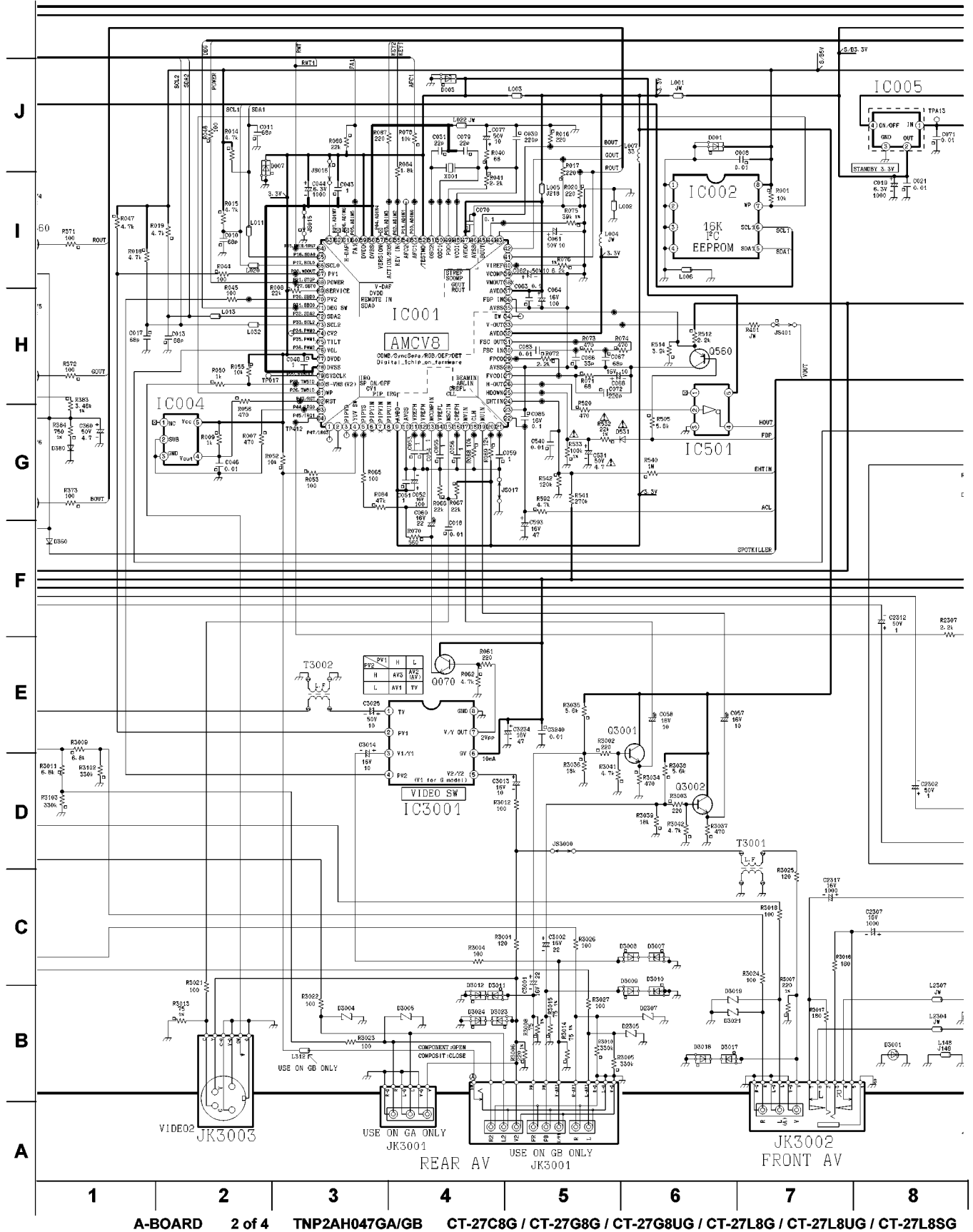

A-BOARD 2 of 4 TNP2AH047GA/GB CT-27C8G / CT-27G8G / CT-27G8UG / CT-27L8G / CT-27L8UG / CT-27L8SG

17.5. A-Board Schematic TNP2AH047GA/GB (page 3 of 4)

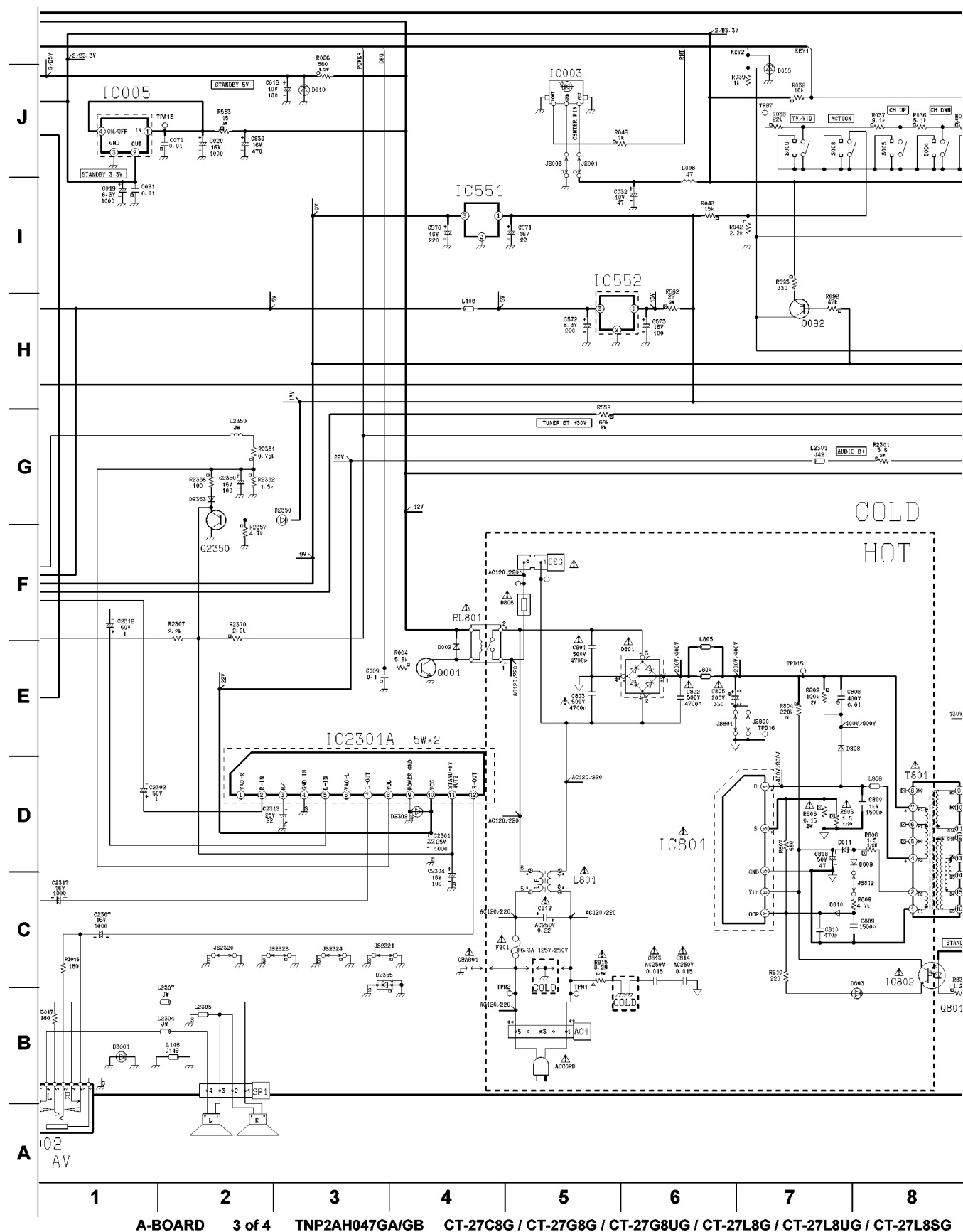

A-BOARD 3 of 4 TNP2AH047GA/GB CT-27C8G / CT-27G8G / CT-27G8UG / CT-27L8G / CT-27L8UG / CT-27L8SG

17.6. A-Board Schematic TNP2AH047GA/GB (page 4 of 4)

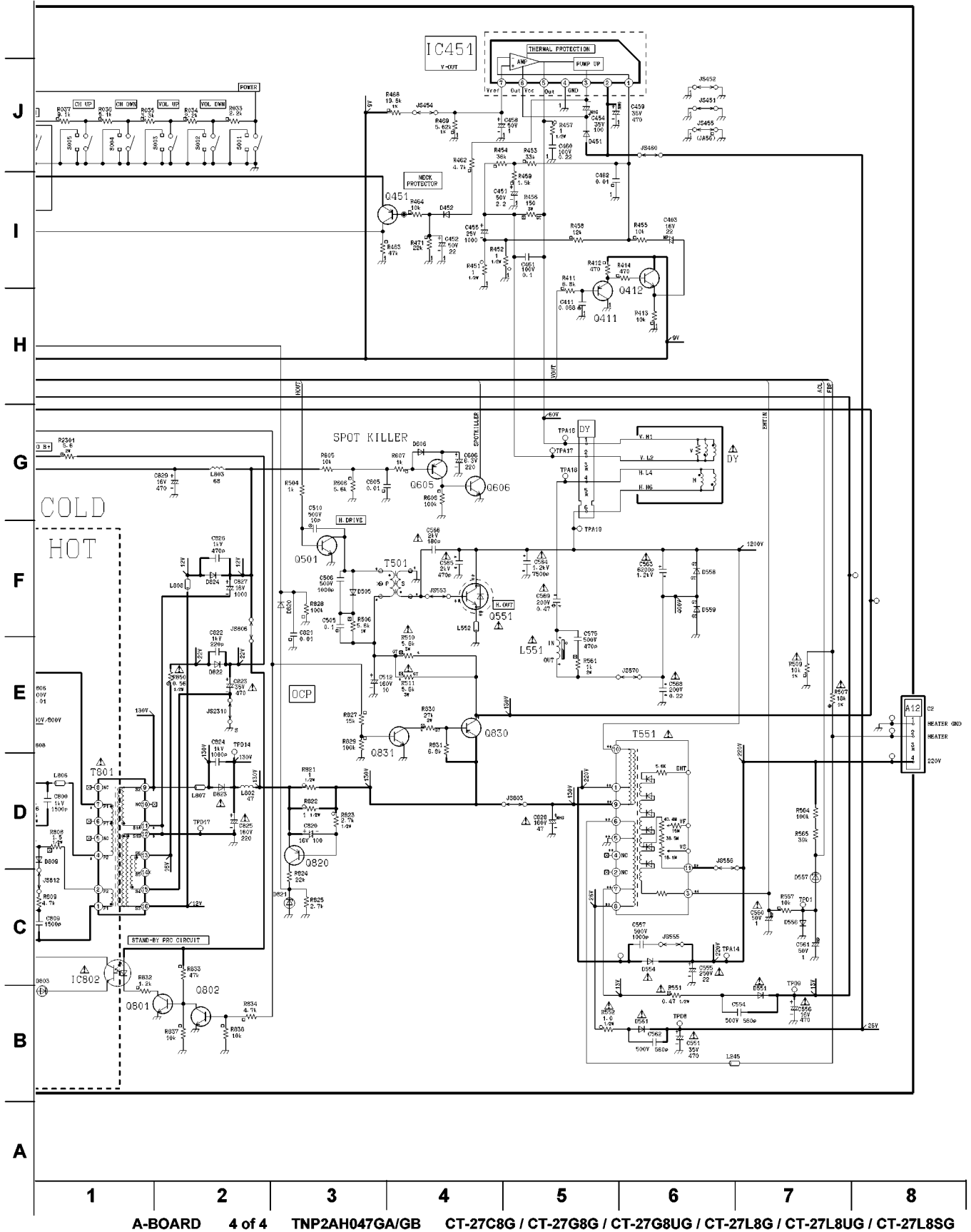

1 2 3 4 5 6 7 8
A-BOARD 4 of 4 TNP2AH047GA/GB CT-27C8G / CT-27G8G / CT-27G8UG / CT-27L8G / CT-27L8UG / CT-27L8SG

17.7. Voltages

A - BOARD																		
IC001				IC002				IC501				IC2201						
1	0.00	43	2.50	1	0.00	1	0.00	1	1.60	13	2.80	
2	0.00	44	1.70	2	0.00	2	1.35	2	2.20	14	2.20	
3	0.00	45	0.00	3	0.00	3	0.00	3	2.20	15	2.50	
4	0.00	46	0.00	4	0.00	4	1.05	4	2.30	16	3.50	
5	0.00	47	3.30	5	3.40	5	3.30	5	2.40	17	0.00	
6	1.20	48	1.90	6	3.40	6	0.07	6	2.60	18	3.20	
7	1.20	49	1.90	7	5.20	7	5.00	7	5.00	19	3.40	
8	1.30	50	1.60	8	5.20	8	2.50	8	2.50	20	0.00	
9	3.30	51	1.70					9	2.60	9	2.60	21	2.20
10	0.00	52	3.30	IC003				10	0.80	10	0.80	22	2.20
11	2.70	53	1.70	1	0.00	11	2.30	11	2.30	23	2.20	
12	1.50	54	1.40	2	3.31	12	2.50	12	2.50	24	2.20	
13	1.40	55	3.30	3	3.27	IC551									
14	0.40	56	1.40					1	12.20						
15	1.60	57	0.00	IC004				2	0.00						
16	2.20	58	0.00	1	0.00	3	9.00							
17	0.07	59	3.30	2	0.00	IC552									
18	1.70	60	3.30	3	0.00	1	7.50							
19	0.00	61	3.30	4	3.30	2	0.00							
20	1.40	62	0.70	5	3.30	3	5.00							
21	1.00	63	3.30					IC801 ↓								
22	2.60	64	3.30					1	-21.00						
23	0.00	65	3.40	IC005				2	N/A						
24	1.90	66	3.50	1	9.10	3	0.10							
25	1.90	67	0.10	2	3.30	4	N/A							
26	1.40	68	3.20	3	0.00	5	0.00							
27	0.00	69	0.00	4	9.10	6	32.24							
28	0.00	70	0.00					7	1.50						
29	1.30	71	0.00	IC451				IC802 ↓								
30	1.80	72	5.20	1	2.00	1	2.30							
31	1.00	73	5.20	2	23.30	2	32.24							
32	3.30	74	0.00	3	1.20										
33	1.70	75	0.00	4	0.00										
34	0.80	76	0.00	5	11.60										
35	0.00	77	3.30	6	23.50										
36	0.60	78	0.00	7	2.00										
37	3.30	79	0.00													
38	3.30	80	3.30													
39	2.30	81	5.20													
40	1.70	82	3.30													
41	0.40	83	0.00													
42	0.40	84	3.30													

CT-27C8G / CT-27G8G / CT-27G8UG / CT-27L8G / CT-27L8UG / CT-27L8SG

A - BOARD

	Q001	Q057	Q058	Q070	Q092	Q2350	Q3001	Q3002	Q354
B	0.00	1.50	1.50	4.12	8.90	5.35	1.30	1.30	4.50
C	13.00	0.00	0.00	8.90	1.40	0.00	3.30	3.30	8.50
E	0.00	0.07	0.07	3.50	3.30	3.14	0.70	0.70	3.80

	Q355	Q356	Q357	Q358	Q359	Q360	Q361	Q362	Q411
B	4.30	4.40	2.60	2.60	2.60	0.50	0.40	0.40	2.25
C	8.40	8.40	4.50	4.30	4.40	0.00	0.00	0.00	0.00
E	3.60	3.70	2.00	2.00	2.00	1.10	1.10	1.10	2.90

	Q412	Q451	Q501	Q551	Q560	Q605	Q606	Q801	Q802
B	2.90	5.10	0.40	0.00	0.30	4.80	0.00	0.00	0.70
C	9.00	1.40	56.80	14.70	0.00	0.00	3.30	12.52	0.00
E	2.40	3.30	0.00	0.00	0.60	4.70	0.00	0.00	0.00

	Q820	Q830	Q831
B	130.40	129.80	0.60
C	0.00	130.40	0.20
E	130.80	130.50	0.00

C - BOARD

	Q351	Q352	Q353
B	3.90	3.80	4.00
C	163.00	165.30	160.20
E	3.60	3.60	3.70

CT-27C8G / CT-27G8G / CT-27G8UG / CT-27L8G / CT-27L8UG / CT-27L8SG

17.8. Waveforms

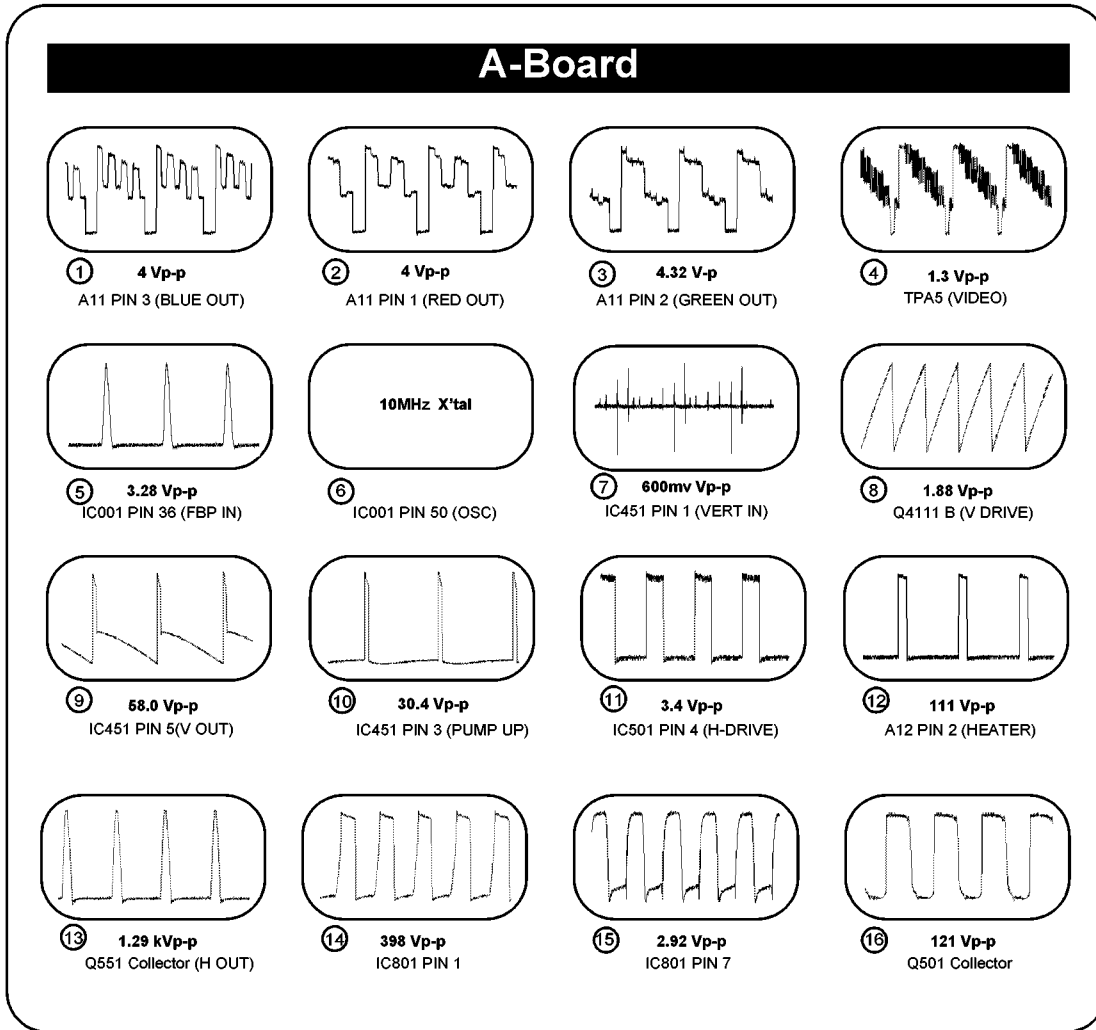

CT-27C8G / CT-27G8G / CT-27G8UG / CT-27L8G / CT-27L8UG / CT-27L8SG

18 Parts Location

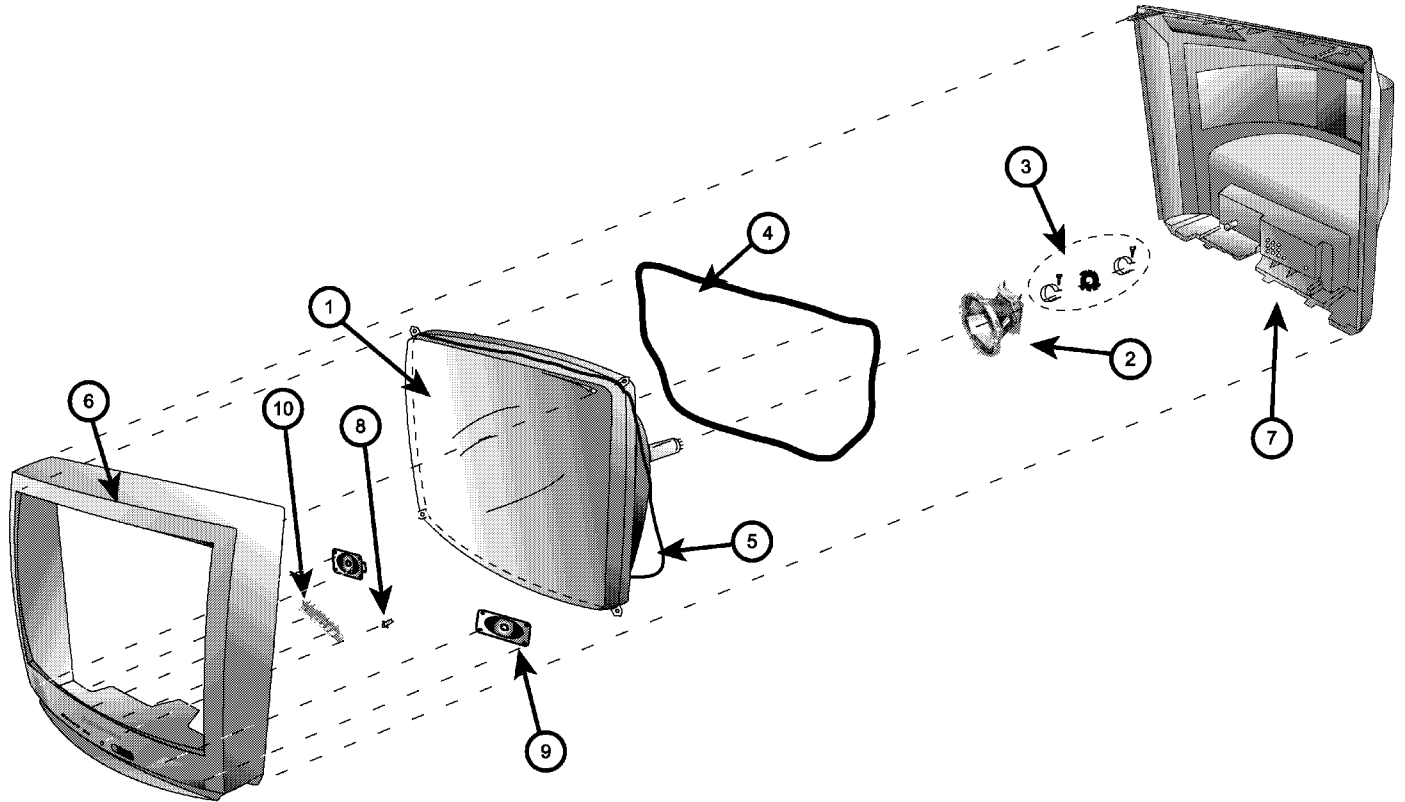

19 Parts List

19.1. Parts List Notes

Important Safety Notice

Components identified by  mark have special characteristics important for safety.
When replacing any of these components, use manufacturer's specified parts.

Abbreviation of part name and description

1. Resistor

Example :

ERD25TJ104 **C** 100K Ω , **J**, 1/4W
Type Allowance

2. Capacitor

Example :

ECKF1H103ZF **C** 0.01 μ F, **Z**, 50V
Type Allowance

Type	Allowance
C : Carbon	F : $\pm 1\%$
F : Fuse	G : $\pm 2\%$
M : Metal Oxide Metal Film	J : $\pm 5\%$ K : $\pm 10\%$
S : Solid	M : $\pm 20\%$
W : Wire Wound	

Type	Allowance
C : Carbon	C : $\pm 0.25\text{pF}$
E : Electrolytic	D : $\pm 0.5\text{pF}$
P : Polyester Polypropylene	F : $\pm 1\text{pF}$ G : $\pm 3\%$
T : Tantalum	J : $\pm 5\%$
	K : $\pm 10\%$
	L : $\pm 15\%$
	M : $\pm 20\%$
	P : $\pm 100\%$, -0%
	Z : $\pm 80\%$, -20%

19.2. Parts List

Ref. No.	Part No.	Part Name & Description	Remarks
CAPRISTORS			
CRA801	TP00842-51	TAPING GAP TERMINAL	△
CAPACITORS			
C003	ECA1HM4R7B	CAP E 4.7UF-50V	
C004	TCJ2VCIH150J	CAP C 15PF-J-50V	
C005	TCJ2VCIH150J	CAP C 15PF-J-50V	
C008	TCJ2VFIH103Z	CAP C .01UF-Z-50V	
C009	ECJ2VFIH104Z	CAP C .1UF-Z-50V	
C010	TCJ2VCIH680J	CAP C 68PF-J-50V	
C011	TCJ2VCIH680J	CAP C 68PF-J-50V	
C013	TCJ2VCIH680J	CAP C 68PF-J-50V	
C016	ECA1AM101B	CAP E 100UF-10V	
C017	TCJ2VCIH680J	CAP C 68PF-J-50V	
C018	TCJ2VFIH103Z	CAP C .01UF-Z-50V	
C019	ECA0JM102B	CAP E 1000UF-6.3V	
C020	ECA1CM102B	CAP E 100UF/16V	
C021	TCJ2VFIH103Z	CAP C .01UF-Z-50V	
C031	TCJ2VCIH220J	CAP C 22PF-J-50V	
C032	ECA1AM470B	CAP E 47UF-10V	
C034	TCJ2VCIH390J	CAP C 39PF-J-50V	
C035	TCJ2VCIH120J	CAP C 12PF-J-50V	
C038	ECA1CM470B	CAP E 47UF/16V	
C039	TCJ2VBIH221K	CAP C 220PF-K-50V	
C041	ECA1HM2R2B	CAP E 2.2UF-50V	
C043	ECJ2VFI105Z	CAP C 1.0UF-Z-16V	
C044	ECA0JM102B	CAP E 1000UF-6.3V	
C046	TCJ2VFIH103Z	CAP C .01UF-Z-50V	
C048	ECJ2VFI105Z	CAP C 1.0UF-Z-16V	
C051	ECJ2VFI105Z	CAP C 1.0UF-Z-16V	
C052	ECA1CM101B	CAP E 100UF/16V	
C053	ECJ2VFI105Z	CAP C 1.0UF-Z-16V	
C054	ECJ2VFI105Z	CAP C 1.0UF-Z-16V	
C055	ECJ2VFI105Z	CAP C 1.0UF-Z-16V	
C056	ECJ2VFI105Z	CAP C 1.0UF-Z-16V	
C057	ECEA1CN100UB	CAP E 10UF-16V	
C058	ECEA1CN100UB	CAP E 10UF-16V	
C059	ECJ2VFI105Z	CAP C 1.0UF-Z-16V	
C060	ECEA1CN220UB	CAP E 22UF-16V	
C061	ECA1HML100B	CAP E 10UF/50V	
C062	ECA1HML100B	CAP E 10UF/50V	
C063	ECJ2VFI104Z	CAP C .1UF-Z-16V CT-27G8G CT-27G8UG CT-27L8G CT-27L8UG	
C063	TCJ2VFI104Z	CAP C .1UF-Z-16V CT-27L8SG CT-27C8G	
C064	ECA1CM101B	CAP E 100UF/16V	
C066	TCJ2VCIH330J	CAP C 33PF-J-50V	
C067	TCJ2VCIH680J	CAP C 68PF-J-50V	
C068	ECA1CM100B	CAP E 10UF-16V	
C070	ECJ2VFI104Z	CAP C .1UF-Z-16V CT-27G8G CT-27G8UG CT-27L8G CT-27L8UG	
C070	TCJ2VFI104Z	CAP C .1UF-Z-16V CT-27L8SG CT-27C8G	
C071	TCJ2VFIH103Z	CAP C .01UF-Z-50V	
C072	TCJ2VBIH221K	CAP C 220PF-K-50V	
C073	TCJ2VCIH101J	CAP C 101PF-K-50V CT-27G8G CT-27G8UG CT-27L8UG	
C077	ECA1HML100B	CAP E 10UF/50V	
C079	TCJ2VCIH220J	CAP C 22PF-J-50V	
C083	TCJ2VFIH103Z	CAP C .01UF-Z-50V	
C085	ECJ2VBI104K	CAP C .1UF-K-16V CT-27G8G CT-27G8UG CT-27L8G CT-27L8UG	
C085	TCJ2VBI104K	CAP C .1UF-K-16V CT-27L8SG CT-27C8G	
C350	ECA1CM101B	CAP E 100UF/16V	
C351	TCJ2VCIH331J	CAP C 330PF-J-50V	
C352	TCJ2VCIH331J	CAP C 330PF-J-50V	
C353	TCJ2VCIH331J	CAP C 330PF-J-50V	
C354	ECKW3D102KBN	CAP C .001UF-K-2KVDC	
C357	EEANA1E1R0B	CAP E 1.0UF-25V	
C359	ECA1CM471B	CAP E 470UF-16V	

Ref. No.	Part No.	Part Name & Description	Remarks
C360	ECA1HM4R7B	CAP E 4.7UF-50V	
C403	ECEA1CN220UB	CAP E 22UF-16V	
C411	ECQB1H683JF3	CAP P .068UF-J-50V	
C451	ECA1HM2R2B	CAP E 2.2UF-50V	
C452	ECA1CM220B	CAP E 100UF-16V	
C454	ECA1VHG101B	CAP E 22UF-35V	
C455	ECA1EM102E	CAP E 1000UF-25V	
C458	ECA1HM010B	CAP E 1UF-50V	
C459	ECA1VHG471E	CAP E 470UF-35V	
C460	ECQB1224KF3	CAP P .22UF-K-100V	
C461	ECQB1104JF3	CAP P .10UF-J-100V	
C462	ECJ2VFIH103Z	CAP C .01UF-Z-50V	
C505	ECQB1H104JF3	CAP P .10UF-J-50V	
C506	ECKR2H102KB5	CAP C 1000PF-K-500V	
C510	ECCR2H100D5	CAP C 10PF-D-500V	
C512	ECA2CM100B	CAP E 10UF-160V	
C531	ECA1HM4R7B	CAP E 4.7UF-50V	△
C540	TCJ2VFIH103Z	CAP C .01UF-Z-50V	
C551	ECA1VHG471B	CAP E 470UF-35V	△
C554	ECKR2H561KB5	CAP C 560PF-K-500V	
C555	ECA2EM220E	CAP E 22UF-250V	△
C556	ECA1CM471B	CAP E 470UF-16V	△
C557	ECKR2H102KB5	CAP C 1000PF-K-500V	
C560	ECEA1HN010UB	CAP E 1UF/50V	
C561	ECEA1HN010UB	CAP E 1UF/50V	
C562	ECKR2H561KB5	CAP C 560PF-K-500V	
C563	ECWH20622JVB	CAP P 6200PF-J-2KV	
C564	ECWH20752JVB	CAP P 7500PF-J-2KV	
C565	ECKW3D471JBP	CAP C 470PF-J-2KV	
C566	ECKW3D181JBP	CAP C 180PF-J-2KV	△
C568	ECWF2224JBB	CAP P .22UF-J-200V	△
C569	ECWF2474JSR	CAP P .47UF-J-200V	△
C570	ECA1CM221B	CAP E 10UF-16V	
C571	ECA1CM220B	CAP E 22UF-16V	
C572	ECA0JM221B	CAP E 220UF-6.3V	
C573	ECA1CM101B	CAP E 100UF/16V	
C575	ECKR2H471KB5	CAP C 470PF-K-500V	
C593	ECA1CM470B	CAP E 47UF/16V	
C605	TCJ2VFIH103Z	CAP C .01UF-Z-50V	
C606	ECA0JM221B	CAP E 220UF-6.3V	
C800	ECKR3A152KBP	CAP C 1500PF-K-1KVDC	
C801	ECKWAE472ZED	CAP C 4700PF-Z-500V	△
C802	ECKWAE472ZED	CAP C 4700PF-Z-500V	△
C803	ECKWAE472ZED	CAP C 4700PF-Z-500V	△
C805	EC0S2DA331BE	CAP E 330UF/200V	△
C806	ECQM4103KZW	CAP P .01UF-K-400V	
C808	ECA1HM470B	CAP E 47UF-50V	
C809	ECKR2H152KB5	CAP C .0015UF-K-500V	
C810	ECKR1H471KB5	CAP C 470PF-K-50V	
C812	ECQU2A224MVA	CAP P .22UF-M-250VAC	△
C813	ECQU2A153MVA	CAP P .015UF-M-250VAC	△
C814	ECQU2A153MVA	CAP P .015UF-M-250VAC	△
C820	ECA1CM101B	CAP E 100UF/16V	
C821	TCJ2VFIH103Z	CAP C .01UF-Z-50V	
C822	ECKR3A221KBP	CAP C 220PF-K-1KV	
C823	ECA1VM471B	CAP E 470UF-35V	△
C824	ECKR3A102KBP	CAP C 1000PF-K-1KV	
C825	EEUMG2C221S	CAP E 220UF-160V	△
C826	ECKR3A471KBP	CAP C 470PF-K-1KV	
C827	ECA1CM102B	CAP E 1000UF/16V	
C828	ECA2CHG470E	CAP E 47UF-160V	
C829	ECA1CM471B	CAP E 470UF-16V	
C830	ECA1CM471B	CAP E 470UF-16V	
C2201	ECA1HM4R7B	CAP E 4.7UF-50V	
C2202	ECA1HM2R2B	CAP E 2.2UF-50V	
C2203	ECA1HM4R7B	CAP E 4.7UF-50V	
C2204	AP106K016CAE	CAP T 10UF/16V	
C2205	ECA1HMR33B	CAP E .33UF-50V	
C2206	ECQB1H223JF3	CAP P .022UF-J-50V	
C2207	AP335K016CAE	CAP T 3.3UF/16V	

Ref. No.	Part No.	Part Name & Description	Remarks
C2208	ECJ2VB1C104K	CAP C .1UF-K-16V CT-27G8G CT-27G8UG CT-27L8G CT-27L8UG	
C2208	TCJ2VB1C104K	CAP C .1UF-K-16V CT-27L8SG CT-27C8G	
C2209	ECJ2VB1C104K	CAP C .1UF-K-16V CT-27G8G CT- 27G8UG CT-27L8G CT-27L8UG	
C2209	TCJ2VB1C104K	CAP C .1UF-K-16V CT-27L8SG CT-27C8G	
C2210	ECJ2VB1C104K	CAP C .1UF-K-16V CT-27G8G CT-27G8UG CT-27L8G CT-27L8UG	
C2210	TCJ2VB1C104K	CAP C .1UF-K-16V CT-27L8SG CT-27C8G	
C2212	ECQB1H473JF3	CAP P .047UF-J-50V	
C2213	ECA1HMR47B	CAP E .47UF-50V	
C2214	ECA1AM101B	CAP E 100UF-10V	
C2215	ERANA1E100B	CAP E 10UF-25V	
C2216	TCJ2VC1H100D	CAP C 10PF-J-50V	
C2217	ECJ2VB1H102K	CAP C .001UF-K-50V	
C2218	ECJ2VB1H102K	CAP C .001UF-K-50V	
C2219	ECJ2VF1C105Z	CAP C 1.0UF-Z-16V	
C2220	ECJ2VF1C105Z	CAP C 1.0UF-Z-16V	
C2301	ECA1EM102E	CAP E 1000UF-25V	
C2302	ECA1HM010B	CAP E 1UF-50V	
C2304	ECA1CM101B	CAP E 100UF/16V	
C2307	ECA1CM102B	CAP E 1000UF/16V	
C2312	ECA1HM010B	CAP E 1UF-50V	
C2313	ECA1EM220B	CAP E 22UF-25V	
C2317	ECA1CM102B	CAP E 1000UF/16V	
C2350	ECA1CM101B	CAP E 100UF/16V	
C2520	ECJ2VF1H103V	CAP C .010UF-V-50V	
C3001	ECA1CM220B	CAP E 22UF-16V	
C3002	ECA1CM220B	CAP E 22UF-16V	
C3011	ECJ2VF1C105Z	CAP C 1.0UF-Z-16V	
C3012	ECA1HM010B	CAP E 1UF-50V	
C3013	ECA1CM100B	CAP E 10UF-16V	
C3014	ECA1CM100B	CAP E 10UF-16V	
C3018	ECA1HM010B	CAP E 1UF-50V	
C3019	ECJ2VF1C105Z	CAP C 1.0UF-Z-16V	
C3025	ECA1HM100B	CAP E 10UF/50V	
C3234	ECA1CM470B	CAP E 47UF/16V	
C3240	TCJ2VF1H103Z	CAP C .01UF-Z-50V	
DIODES			
D001	MAZ30680ML	DIODE	
D002	MA2C165001VT	DIODE	
D003	MAZ30510HL	DIODE SILICON	
D006	MAZ33000HL	DIODE	
D007	MAZ30510HL	DIODE SILICON	
D010	MAZ40510MF	DIODE ZENER	
D055	MAZ40330MF	DIODE ZENER	
D360	MA2C165001VT	DIODE	
D380	MA2C029WBF	DIODE	
D451	BOEAKL000008	DIODE RECTIFIER	
D452	MA2C165001VT	DIODE	
D505	D1NL40V70	DIODE	
D531	MA2C165001VT	DIODE	△
D551	BOHAMM000072	DIODE FAST RECOVERY	△
D554	AU02V0	DIODE	△
D556	MA2C165001VT	DIODE	
D557	MAZ40270LF	DIODE ZENER	
D558	BOHANV000008	DIODE	
D559	EU2	DIODE	
D561	AU02V0	DIODE	△
D606	MA2C165001VT	DIODE	
D801	D3SBA60-4103	DIODE	△
D803	MAZ41200MF	DIODE ZENER	
D806	TAP2AA0003	PTC 3-OHM	△
D808	SARS01V1	DIODE	
D809	BOHAJP000015	DIODE	
D810	BOHAJP000015	DIODE	
D811	BOHAJP000015	DIODE	
D820	MA2C165001VT	DIODE	
D821	MAZ40470HF	DIODE ZENER	
D822	BOHAMM000103	DIODE	

Ref. No.	Part No.	Part Name & Description	Remarks
D823	S3L60P154004	DIODE	△
D824	BOHAMM000072	DIODE FAST RECOVERY	
D2302	MAZ43000MF	DIODE ZENER	
D2305	CVS20A120MTA	DIODE	
D2307	CVS20A120MTA	DIODE	
D2350	MAZ40680MF	DIODE ZENER	
D2353	MA2C165001VT	DIODE	
D2355	MAZ30510HL	DIODE SILICON	
D3001	MAZ40510MF	DIODE ZENER	
D3004	CVS20A120MTA	DIODE	
D3005	CVS20A120MTA	DIODE	
D3007	MAZ31100ML	DIODE ZENER	
D3008	MAZ31100ML	DIODE ZENER	
D3009	MAZ31100ML	DIODE ZENER	
D3010	MAZ31100ML	DIODE ZENER	
D3011	MAZ31100ML	DIODE ZENER	
D3012	MAZ31100ML	DIODE ZENER	
D3017	MAZ31100ML	DIODE ZENER	
D3018	MAZ31100ML	DIODE ZENER	
D3019	CVS20A120MTA	DIODE	
D3021	CVS20A120MTA	DIODE	
D3023	MAZ31100ML	DIODE ZENER	
D3024	MAZ31100ML	DIODE ZENER	
FUSES			
F801	XBA2A00101	FUSE 6.3A 125V	△
INTEGRATED CIRCUITS			
IC001	MN101E03GTB3	MPU	
IC002	TVR2AJ165S	EEPROM CT-27G8G CT-27G8UG	
IC002	TVR2AJ166S	EEPROM CT-27L8G CT-27L8UG CT-27L8SG CT-27C8G	
IC003	GF1UE282GK	IR SENSOR	
IC004	PST9128NR	RESET	
IC005	PQ3RD13	3.3V STBY REGULATOR	
IC451	AN5522	VERTICAL OUTPUT AMPLIFIER	
IC501	NC7SZU04M5X	H-DRIVE INVERTER	
IC551	AN78M09LB	9V VOLTAGE REGULATOR	
IC552	AN78M05LB	5V VOLTAGE REGULATOR	
IC801	STRW5634	MAIN POWER SUPPLY	△
IC802	ON3171RLF	OPTO-COUPLER	△
IC2201	AN5829S-E1V	MTS	
IC2301	AN17807A	AUDIO AMPLIFIER	
IC3001	MM114XFBE	VIDEO SWITCH	
COILS			
L002	EXCELSA39V	FERRITE BEAD	
L003	EXCELDR35V	FERRITE BEAD	
L005	EXCELSA35V	FERRITE BEAD	
L006	EXCELSA35T	FERRITE BEAD	
L007	ELESN330JA	COIL PEAKING 33UH	
L008	G0C470KA0029	COIL PEAKING 47UH	
L010	G0C2R2KA0029	COIL PEAKING 2.2UH	
L011	EXCELSA26T	FERRITE BEAD	
L012	G0C2R2KA0029	COIL PEAKING 2.2UH	
L013	EXCELSA26T	FERRITE BEAD	
L014	ELESN180KA	COIL PEAKING 18UH	
L015	ELESN3R3JA	COIL PEAKING 3.3UH	
L020	EXCELSA26T	FERRITE BEAD	
L032	EXCELSA26T	FERRITE BEAD	
L108	EXCELSA35V	FERRITE BEAD	
L110	G0C101KA0021	COIL PEAKING 100UH CT-27G8G CT-27G8UG CT-27L8G CT-27L8UG	
L148	EXCELSA35T	FERRITE BEAD	
L245	EXCELSA35V	FERRITE BEAD	
L312	EXCELSA24T	FERRITE BEAD	
L551	ELH5L7103	COIL	△
L552	EXCELSA39V	FERRITE BEAD	
L801	ELF21V018A	COIL	
L802	TALL08T470KA	COIL	
L803	TALL08T680KA	COIL	
L804	EXCELDR35V	FERRITE BEAD	
L805	EXCELDR35V	FERRITE BEAD	
L806	EXCELDR35V	FERRITE BEAD	

Ref. No.	Part No.	Part Name & Description	Remarks
L807	EXCELSA35V	FERRITE BEAD	
L808	EXCELSA35V	FERRITE BEAD	
L2301	EXCELD35V	FERRITE BEAD CT-27L8G CT-27L8UG CT-27L8SG CT-27C8G	
L2301	EXCELSA35V	FERRITE BEAD	
L2305	EXCELSA35V	FERRITE BEAD	
TRANSISTORS			
Q001	2SD601ARTX	TRANSISTOR	
Q070	2SD601ARTX	TRANSISTOR	
Q092	2SB709ARTX	TRANSISTOR	
Q351	2SC3063RL	TRANSISTOR	
Q352	2SC3063RL	TRANSISTOR	
Q353	2SC3063RL	TRANSISTOR	
Q354	2SD601ARTX	TRANSISTOR	
Q355	2SD601ARTX	TRANSISTOR	
Q356	2SD601ARTX	TRANSISTOR	
Q357	2SD601ARTX	TRANSISTOR	
Q358	2SD601ARTX	TRANSISTOR	
Q359	2SD601ARTX	TRANSISTOR	
Q360	2SB709ARTX	TRANSISTOR	
Q361	2SB709ARTX	TRANSISTOR	
Q362	2SB709ARTX	TRANSISTOR	
Q411	2SB0710AQL	TRANSISTOR	
Q412	2SD0602AQL	TRANSISTOR	
Q451	2SB709ARTX	TRANSISTOR	
Q501	2SC4212HLB	TRANSISTOR	
Q551	2SC5902000LK	TRANSISTOR	△
Q560	2SB709ARTX	TRANSISTOR	
Q605	2SB709ARTX	TRANSISTOR	
Q606	2SD601ARTX	TRANSISTOR	
Q801	2SD601ARTX	TRANSISTOR	
Q802	2SD601ARTX	TRANSISTOR	
Q820	2SA1767QTA	TRANSISTOR	
Q830	2SB1011QRL	TRANSISTOR	
Q831	2SC1473ATA	TRANSISTOR	
Q2350	2SB709ARTX	TRANSISTOR	
Q3001	2SD601ARTX	TRANSISTOR	
Q3002	2SD601ARTX	TRANSISTOR	
RELAYS			
RL801	K6B1AGA00042	RELAY	△
RESISTORS			
R001	ERJ6GEYJ103V	RES M 10K-J-1/10W	
R004	ERJ6GEYJ562V	RES M 5.6K-J-1/10W	
R005	ERJ6GEYJ471V	RES M 470-J-1/10W	
R007	ERJ6GEYJ471V	RES M 470-J-1/10W	
R008	ERJ6GEYJ223V	RES M 22K-J-1/10W	
R009	ERJ6GEYJ102V	RES M 1K-J-1/10W	
R014	ERJ6GEYJ472V	RES M 4.7K-J-1/10W	
R015	ERJ6GEYJ472V	RES M 4.7K-J-1/10W	
R016	ERJ6GEYJ221V	RES M 220-J-1/10W	
R017	ERJ6GEYJ221V	RES M 220-J-1/10W	
R018	ERJ6GEYJ472V	RES M 4.7K-J-1/10W	
R019	ERJ6GEYJ472V	RES M 4.7K-J-1/10W	
R020	ERJ6GEYJ221V	RES M 220-J-1/10W	
R021	ERJ6GEYJ101V	RES M 100-J-1/10W	
R022	ERJ6GEYJ101V	RES M 100-J-1/10W	
R023	ERJ6GEYJ102V	RES M 1K-J-1/10W	
R024	ERJ6GEYJ101V	RES M 100-J-1/10W	
R025	ERJ6GEYJ101V	RES M 100-J-1/10W	
R026	ERDS1FJ561P	RES C 560-J-1/2W	
R032	ERJ6GEYJ103V	RES M 10K-J-1/10W	
R033	ERJ6GEYJ222V	RES M 2.2K-J-1/10W	
R034	ERJ6GEYJ222V	RES M 2.2K-J-1/10W	
R035	ERJ6GEYJ332V	RES M 3.3K-J-1/10W	
R036	ERJ6GEYJ512V	RES M 5.1K-J-1/10W	
R037	ERJ6GEYJ912V	RES M 9.1K-J-1/10W	
R038	ERJ6GEYJ223V	RES M 22K-J-1/10W	
R039	ERDS2TJ102T	RES C 1K-J-1/4W	
R040	ERJ6GEYJ680V	RES M 68-J-1/10W	
R041	ERJ6GEYJ222V	RES M 2.2K-J-1/10W	
R042	ERJ6GEYJ222V	RES M 2.2K-J-1/10W	
R043	ERJ6GEYJ153V	RES M 15K-J-1/10W	

Ref. No.	Part No.	Part Name & Description	Remarks
R044	ERJ6GEYJ101V	RES M 100-J-1/10W	
R045	ERDS2TJ101T	RES C 100-J-1/4W	
R046	ERJ6GEYJ102V	RES M 1K-J-1/10W	
R047	ERJ6GEYJ472V	RES M 4.7K-J-1/10W	
R048	ERJ6GEYJ101V	RES M 100-J-1/10W	
R050	ERJ6GEYJ102V	RES M 1K-J-1/10W	
R052	ERJ6GEYJ103V	RES M 10K-J-1/10W	
R053	ERJ6GEYJ101V	RES M 100-J-1/10W	
R055	ERJ6GEYJ103V	RES M 10K-J-1/10W	
R056	ERJ6GEYJ471V	RES M 470-J-1/10W	
R057	ERJ6GEYJ101V	RES M 100-J-1/10W	
R060	ERJ6GEYJ101V	RES M 100-J-1/10W	
R061	ERJ6GEYJ221V	RES M 220-J-1/10W	
R062	ERJ6GEYJ472V	RES M 4.7K-J-1/10W	
R063	ERDS2TJ101T	RES C 100-J-1/4W	
R064	ERJ6GEYJ473V	RES M 47K-J-1/10W	
R065	ERDS2TJ101T	RES C 100-J-1/4W	
R066	ERJ6GEYJ223V	RES M 22K-J-1/10W	
R067	ERJ6GEYJ223V	RES M 22K-J-1/10W	
R068	ERJ6GEYJ103V	RES M 10K-J-1/10W	
R069	ERJ6GEYJ123V	RES M 12K-J-1/10W	
R070	ERJ6GEYJ561V	RES M 560-J-1/10W	
R071	ERJ6GEYJ680V	RES M 68-J-1/10W	
R072	ERJ6GEYJ222V	RES M 2.2K-J-1/10W	
R073	ERJ6GEYJ471V	RES M 470-J-1/10W	
R074	ERJ6GEYJ471V	RES M 470-J-1/10W	
R075	ERJ6ENF3902V	RES M 39K-F-1/10W	
R076	ERJ6ENF6201V	RES M 6.2K-F-1/10W	
R077	ERJ6GEYJ103V	RES M 10K-J-1/10W	
R078	ERJ6GEYJ103V	RES M 10K-J-1/10W	
R084	ERDS2TJ182T	RES C 1.8K-J-1/4W	
R087	ERDS2TJ221T	RES C 220-J-1/4W	
R088	ERJ6GEYJ223V	RES M 22K-J-1/10W	
R092	ERJ6GEYJ473V	RES M 47K-J-1/10W	
R093	ERJ6GEYJ331V	RES M 330-J-1/10W	
R351	ERG2FJ123H	RES M 12K-J-2W	
R352	ERG2FJ123H	RES M 12K-J-2W	
R353	ERG2FJ123H	RES M 12K-J-2W	
R354	ERC12GK272C	RES C 2.7K-K-1/2W	
R355	ERC12GK272C	RES C 2.7K-K-1/2W	
R356	ERC12GK272C	RES C 2.7K-K-1/2W	
R357	ERJ6ENF3000V	RES M 300-F-1/10W	
R358	ERJ6ENF3000V	RES M 300-F-1/10W	
R359	ERJ6ENF3000V	RES M 300-F-1/10W	
R360	ERJ6ENF7500V	RES M 750-F-1/10W	
R361	ERJ6ENF7500V	RES M 750-F-1/10W	
R362	ERJ6ENF7500V	RES M 750-F-1/10W	
R363	ERJ6GEYJ101V	RES M 100-J-1/10W	
R364	ERJ6GEYJ101V	RES M 100-J-1/10W	
R365	ERJ6GEYJ101V	RES M 100-J-1/10W	
R371	ERJ6GEYJ101V	RES M 100-J-1/10W	
R372	ERJ6GEYJ101V	RES M 100-J-1/10W	
R373	ERJ6GEYJ101V	RES M 100-J-1/10W	
R374	ERJ6GEYJ102V	RES M 1K-J-1/10W	
R375	ERJ6GEYJ102V	RES M 1K-J-1/10W	
R376	ERJ6GEYJ102V	RES M 1K-J-1/10W	
R377	ERJ6ENF3300V	RES M 330-F-1/10W	
R378	ERJ6ENF3300V	RES M 330-F-1/10W	
R379	ERJ6ENF3300V	RES M 330-F-1/10W	
R380	ERJ6ENF1501V	RES M 1.5K-F-1/10W	
R381	ERJ6ENF1501V	RES M 1.5K-F-1/10W	
R382	ERJ6ENF1501V	RES M 1.5K-F-1/10W	
R383	ERJ6ENF3481V	RES M 3.48K-F-1/10W	
R384	ERJ6ENF7500V	RES M 750-F-1/10W	
R385	ERDS1FJ150P	RES C 15-J-1/2W	
R389	ERJ6GEYJ102V	RES M 1K-J-1/10W	
R390	ERJ6GEYJ102V	RES M 1K-J-1/10W	
R391	ERJ6GEYJ102V	RES M 1K-J-1/10W	
R411	ERJ6GEYJ682V	RES M 6.8K-J-1/10W	
R412	ERJ6GEYJ471V	RES M 470-J-1/10W	
R413	ERJ6GEYJ103V	RES M 10K-J-1/10W	
R414	ERJ6GEYJ471V	RES M 470-J-1/10W	
R451	ERDS1FJ1R0P	RES C 1.0-J-1/2W	

Ref. No.	Part No.	Part Name & Description	Remarks
R453	ERJ6GEYJ333V	RES M 33K-J-1/10W	
R454	ERJ6GEYJ363V	RES M 36K-J-1/10W	
R455	ERJ6GEYJ103V	RES M 10K-J-1/10W	
R456	ERG3FJ151	RES M 150-J-3W	
R457	ERDS1FJ1R0P	RES C 1.0-J-1/2W	
R458	ERJ6GEYJ123V	RES M 12K-J-1/10W	
R459	ERJ6GEYJ152V	RES M 1.5K-J-1/10W	
R462	ERJ6GEYJ472V	RES M 4.7K-J-1/10W	
R463	ERJ6GEYJ473V	RES M 47K-J-1/10W	
R464	ERJ6GEYJ103V	RES M 10K-J-1/10W	
R468	ERJ6ENF1962V	RES M 19.6K-F-1/10W	
R469	ERJ6ENF5621V	RES M 5.62K-F-1/10W	
R471	ERJ6GEYJ223V	RES M 22K-J-1/10W	
R504	ERDS2TJ102T	RES C 1K-J-1/4W	
R505	ERJ6GEYJ562V	RES M 5.6K-J-1/10W	
R506	ERGL5J562P	RES C 5.6K-J-1W	
R507	EROS2THF1802	RES M 18K-F-1/4W	△
R509	ERJ6ENF1002V	RES M 10K-F-1/10W	△
R510	ERG3FJ562	RES M 5.6K-J-3W	△
R511	ERG3FJ562	RES M 5.6K-J-3W	△
R512	ERJ6GEYJ222V	RES M 2.2K-J-1/10W	
R514	ERJ6GEYJ392V	RES M 3.9K-J-1/10W	
R520	ERJ6GEYJ471V	RES M 470-J-1/10W	
R532	ERJ6ENF2202V	RES M 22K-F-1/10W	△
R533	ERJ6ENF1003V	RES M 100K-F-1/10W	△
R540	ERJ6GEYJ105V	RES M 1M-J-1/10W	
R541	ERDS2TJ274T	RES C 27K-J-1/4W	
R542	ERJ6GEYJ124V	RES M 120K-J-1/10W	
R551	ERX12SJR47P	RES M .47-J-1/2W	△
R552	ERDS1FJ1R0T	RES C 1.0-J-1/2W	△
R557	ERJ6GEYJ103V	RES M 10K-J-1/10W	
R558	ERQ1CKPR56S	RES F .56-K-1W	△
R559	ERG2FJ683H	RES M 12K-J-2W	
R561	ERG2FJ102H	RES M 1K-J-2W	
R562	ERG2FJ270H	RES M 27-J-2W	
R563	ERG3FJ150H	RES M 15-J-3W	
R564	ERDS2TJ104T	RES C 100K-J-1/4W	
R565	ERDS2TJ393T	RES C 39K-J-1/4W	
R592	ERJ6GEYJ472V	RES M 4.7K-J-1/10W	
R605	ERDS2TJ103T	RES C 10K-J-1/4W	
R606	ERJ6GEYJ562V	RES M 5.6K-J-1/10W	
R607	ERJ6GEYJ102V	RES M 1K-J-1/10W	
R608	ERJ6GEYJ104V	RES M 100K-J-1/10W	
R802	ERG2FJ104H	RES M 100K-J-2W	
R804	ERGLDJ224P	RES M 220K-J-1W	
R805	ERX2FZJR15H	RES M .18-J-2W	△
R806	ERX12SJR15P	RES M 4.5-J-1/2W	△
R807	ERDS2TJ681T	RES C 680-J-1/4W	
R808	ERX12SJR15P	RES M 1.5-J-1/2W	
R809	ERDS2TJ472T	RES C 4.7K-J-1/4	
R810	ERDS2TJ221T	RES C 220-J-1/4W	
R815	ERC12ZGK825D	RES C 8.2MEG-K-1/2W	△
R821	ERDS1FJ1R0T	RES C 1.0-J-1/2W	
R822	ERDS1FJ1R0T	RES C 1.0-J-1/2W	
R823	ERDS1FJ272T	RES C 2.7K-J-1/2W	
R824	ERDS2TJ223T	RES C 22K-J-1/4W	
R825	ERDS2TJ272T	RES C 2.7K-J-1/4W	
R827	ERJ6GEYJ153V	RES M 15K-J-1/10W	
R828	ERJ6GEYJ104V	RES M 100K-J-1/10W	
R829	ERJ6GEYJ104V	RES M 100K-J-1/10W	
R830	ERG2FJ273H	RES M 27K-J-2W	
R831	ERDS2TJ682T	RES C 6.8K-J-1/4W	
R832	ERJ6GEYJ122V	RES M 1.2K-J-1/10W	
R833	ERJ6GEYJ473V	RES M 47K-J-1/10W	
R834	ERJ6GEYJ472V	RES M 4.7K-J-1/10W	
R837	ERJ6GEYJ103V	RES M 10K-J-1/10W	
R838	ERJ6GEYJ103V	RES M 10K-J-1/10W	
R850	ERQ12HJR56P	RES F .56-J-1/2W	△
R202	ERJ6GEYJ222V	RES M 2.2K-J-1/10W	
R2201	ERJ6GEYJ224V	RES M 220K-J-1/10W	
R2203	ERJ6GEYJ272V	RES M 2.7K-J-1/10W	
R2204	ERJ6GEYJ272V	RES M 2.7K-J-1/10W	
R2205	ERDS2TJ101T	RES C 100-J-1/4W	

Ref. No.	Part No.	Part Name & Description	Remarks
R2206	ERDS2TJ273T	RES C 27K-J-1/4W	
R2207	ERJ6GEYJ152V	RES M 1.5K-J-1/10W	
R2208	ERJ6GEYJ152V	RES M 1.5K-J-1/10W	
R2301	ERQ2CJP5R6S	RES F 5.6-J-2W	
R2307	ERDS2TJ222T	RES C 2.2K-J-1/4W	
R2351	ERJ6GEYJ751V	RES M 750-J-1/10W	
R2352	ERJ6GEYJ152V	RES M 1.5K-J-1/10W	
R2356	ERJ6GEYJ101V	RES M 100-J-1/10W	
R2357	ERJ6GEYJ472V	RES M 4.7K-J-1/10W	
R2362	ERJ6GEYJ221V	RES M 220-J-1/10W	
R2364	ERJ6ENF1001V	RES M 1K-F-1/10W	
R2370	ERJ6GEYJ222V	RES M 2.2K-J-1/10W	
R3002	ERJ6GEYJ221V	RES M 220-J-1/10W	
R3003	ERJ6GEYJ221V	RES M 220-J-1/10W	
R3004	ERDS2TJ101T	RES C 100-J-1/4W	
R3005	ERJ6GEYJ334V	RES M 330K-J-1/10W	
R3006	ERJ6GEYJ151V	RES M 150-J-1/10W	
R3007	ERJ6GEYJ151V	RES M 150-J-1/10W	
R3008	ERJ6ENF75R0V	RES M 75.0-F-1/10W	
R3009	ERJ6GEYJ682V	RES M 6.8K-J-1/10W	
R3010	ERJ6GEYJ334V	RES M 330K-J-1/10W	
R3011	ERJ6GEYJ682V	RES M 6.8K-J-1/10W	
R3012	ERDS2TJ101T	RES C 100-J-1/4W	
R3013	ERJ6ENF75R0V	RES M 75.0-F-1/10W	
R3014	ERJ6ENF75R0V	RES M 75.0-F-1/10W	
R3015	ERJ6ENF75R0V	RES M 75.0-F-1/10W	
R3016	ERDS2TJ181T	RES C 180-J-1/4W	
R3017	ERDS2TJ181T	RES C 180-J-1/4W	
R3018	ERDS2TJ101T	RES C 100-J-1/4W	
R3019	ERJ6GEYJ682V	RES M 6.8K-J-1/10W	
R3020	ERJ6GEYJ682V	RES M 6.8K-J-1/10W	
R3021	ERDS2TJ101T	RES C 100-J-1/4W	
R3022	ERDS2TJ101T	RES C 100-J-1/4W	
R3023	ERDS2TJ101T	RES C 100-J-1/4W	
R3024	ERDS2TJ101T	RES C 100-J-1/4W	
R3025	ERDS2TJ101T	RES C 100-J-1/4W	
R3026	ERDS2TJ101T	RES C 100-J-1/4W	
R3027	ERDS2TJ101T	RES C 100-J-1/4W	
R3034	ERJ6GEYJ471V	RES M 470-J-1/10W	
R3035	ERJ6GEYJ562V	RES M 5.6K-J-1/10W	
R3036	ERJ6GEYJ183V	RES M 18K-J-1/10W	
R3037	ERJ6GEYJ471V	RES M 470-J-1/10W	
R3038	ERJ6GEYJ562V	RES M 5.6K-J-1/10W	
R3039	ERJ6GEYJ183V	RES M 18K-J-1/10W	
R3041	ERJ6GEYJ472V	RES M 4.7K-J-1/10W	
R3042	ERJ6GEYJ472V	RES M 4.7K-J-1/10W	
R3101	ERJ6GEYJ334V	RES M 330K-J-1/10W	
R3102	ERJ6GEYJ334V	RES M 330K-J-1/10W	
R3103	ERJ6GEYJ334V	RES M 330K-J-1/10W	
R3104	ERJ6GEYJ334V	RES M 330K-J-1/10W	
SWITCHES			
S001	EVQPF106K	SWITCH	
S002	EVQPF106K	SWITCH	
S003	EVQPF106K	SWITCH	
S004	EVQPF106K	SWITCH	
S005	EVQPF106K	SWITCH	
S008	EVQPF106K	SWITCH	
S009	EVQPF106K	SWITCH	
TRANSFORMERS			
T501	ETH19Y211AZ	TRANSFORMER	
T551	KFT4AA348F2	TRANSFORMER FLYBACK	△
T801	ETS35AA6B5NC	TRANSFORMER	△
T3001	TF0402B04P03	TRANSFORMER	
T3002	TF0402B04P03	TRANSFORMER	
CRYSTALS/FILTERS			
X001	A1100005BD	CRYSTAL	
OTHERS			
TNR001	ENG36621G	TUNER	△
M001	TSX2AA0361	AC LINE CORD	
M002	TMW2A97121	STRAIN RELIEF FOR AC CORD CT-27G8G CT-27G8UG CT-27L8G CT-27L8UG CT-27L8SG	
M003	TJSC00300	CRT SOCKET	△

Ref. No.	Part No.	Part Name & Description	Remarks
1	M68LGL061XA	27 INCH CRT	△
2	TLY2AA031	DEFLECTION YOKE	△
3	JH291U-009	PURITY AND CONVERGENCE RINGS	
4	TLK2AA0011	DEGAUSSING COIL	△
5	TXF3A011EV	DAG GND	
M004	TMM2A30702	YOKE WEDGE	
M005	0FMK014ZZ	CONVERGENCE CORRECTOR STRIP	
M006	TSN63115-4	PURITY MAGNET	
6	TXFKY10GSER	FRONT CABINET CT-27L8G CT-27L8UG	
	TXFKY20GSER	FRONT CABINET CT-27C8G	
	TXFKY21GSER	FRONT CABINET CT-27L8SG	
7	TXFKU09GSER	BACK CABINET CT-27G8G CT-27G8UG CT-27L8G CT-27L8UG CT-27L8SG	
	TXFKU01GSER	BACK CABINET CT-27C8G	
8	TKX2AA00401	IR SENSOR GUIDE CT-27G8G CT-27G8UG	
	TKX2AA00404	IR SENSOR GUIDE CT-27L8G CT-27L8UG CT-27L8SG	
	TKX2AA00407	IR SENSOR GUIDE CT-27C8G	
9	TAS2AA0029	1.5W 16-OHM SPEAKER	
10	TBX2AA0122	7-KEY BUTTON (GRAY) CT-27L8G CT-27L8UG CT-27L8SG	
	TBX2AA1701GS	7-KEY BUTTON CT-27G8G CT-27G8UG	
	TBX2AA2602	7-KEY BUTTON CT-27C8G	
JK3001	TJB2AA0221	REAR A/V JACK CT-27L8G CT-27L8UG CT-27L8SG CT-27C8G	
JK3001	TJB2A9064B	REAR A/V JACK CT-27G8G CT-27G8UG	
JK3002	TJB2AA0046	FRONT A/V JACK	
JK3003	TJB2AA0421	TERMINAL S-VIDEO	
OTHER ACCESSORIES			
M007	TQB2AA0461	OWNERS MANUAL	
M008	EUR7613Z10	REMOTE CONTROL CT-27C8G	
M009	EUR7713010	REMOTE CONTROL CT-27G8G CT-27G8UG CT-27L8G CT-27L8UG CT-27L8SG	
M010	UR76EC0303A	REMOTE CONTROL BATTERY COVER CT-27C8G	
M011	UR77EC1303A	REMOTE CONTROL BATTERY COVER CT-27G8G CT-27G8UG CT-27L8G CT-27L8UG CT-27L8SG	

Service Manual

Color Television

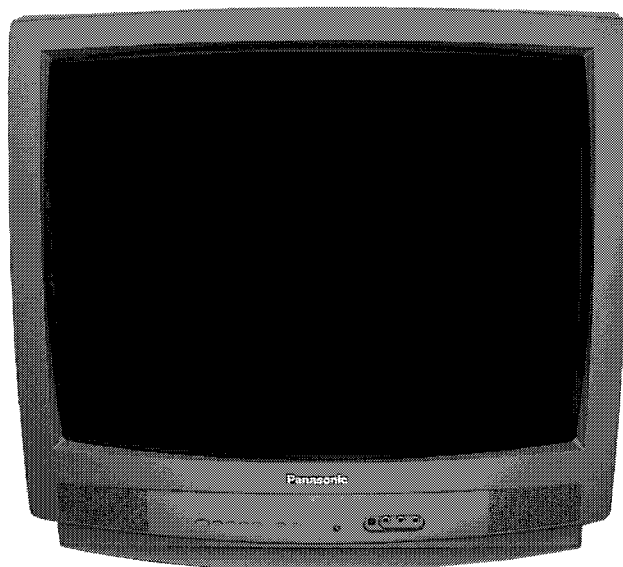

CT-25L8G
CT-25L8UG
CT-20L8G
CT-20G8G
CT-20G8SG
NA10

⚠ WARNING

This service information is designed for experienced repair technicians only and is not designed for use by the general public. It does not contain warnings or cautions to advise non-technical individuals of potential dangers in attempting to service a product. Products powered by electricity should be serviced or repaired only by experienced professional technicians. Any attempt to service or repair the product or products dealt with in this service information by anyone else could result in serious injury or death.

IMPORTANT SAFETY NOTICE

There are special components used in this equipment which are important for safety. These parts are marked by ⚠ in the Schematic Diagrams, Circuit Board Diagrams, Exploded Views and Replacement Parts List. It is essential that these critical parts should be replaced with manufacturer's specified parts to prevent shock, fire or other hazards. Do not modify the original design without permission of manufacturer.

CONTENTS

	Page		Page
1 Safety precautions	3	11.1. Permalloy convergence corrector strip (Part No. 0FMK014ZZ)	13
2 Service notes	4	12 Service mode (electronic adjustments)	14
2.1. X-Ray Protection Circuit Check & Adjustments	5	12.1. Service adjustment default values for items	15
3 EEPROM replacement	5	12.2. Instructional Flow Chart for Service Mode	16
4 About lead free solder (PbF)	6	12.3. Instructional flow chart for service mode (continued).	17
5 Receiver feature table	7	13 Service adjustments (electronic controls)	18
6 Board description table	7	13.1. Sub-Brightness and ContrastService DAC adjustment (BRIGH, CONT)	18
7 TV Location of controls	8	13.2. Color output adjustmentService DAC adjustment (COLOR, TINT)	18
8 Location of controls (EUR7713010 remote)	9	13.3. Color output adjustmentService DAC adjustment(COLOR, TINT, B-Y_G)	18
9 Dissassembly for service	10		
9.1. Disassembly for CRT replacement	10		
10 Chassis service adjustment procedures	11		
11 Purity and convergence procedure	12		

13.4. Color temperature adjustment(B/W Tracking)Service DAC Adjust.(CUT R) (CUT G) (CUT B) (R DR) (B DR)	19	18.1. English Schematic Notes	36
13.5. Deflection adjustments	19	18.2. Notas de Esquemáticos en Español	37
13.6. MTS circuit adjustments	21	18.3. A-Board Schematic TNP2AH047AA/AB (page 1 of 4)	38
13.7. Clock adjustment (CLOCK)	21	18.4. A-Board Schematic TNP2AH047AA/AB (page 2 of 4)	39
13.8. Service Adjustments Mechanical Controls	21	18.5. A-Board Schematic TNP2AH047AA/AB (page 3 of 4)	40
14 Identification of Components	22	18.6. A-Board Schematic TNP2AH047AA/AB (page 4 of 4)	41
14.1. Back Cover Removal	22	18.7. A-Board Schematic TNP2AH047FA (page 1 of 4)	42
14.2. Chassis Components	23	18.8. A-Board Schematic TNP2AH047FA(page 2 of 4)	43
15 Reference for PDF Colors	28	18.9. A-Board Schematic TNP2AH047FA (page 3 of 4)	44
16 Conductor Views	29	18.10. A-Board Schematic TNP2AH047FA (page 4 of 4)	45
16.1. A-Board Printed Circuit (Left Side)	30	18.11. C-Board Schematic TNP2AA122AA/FA	46
16.2. A-Board & C Board Printed Circuit (Right Side)	31	18.12. Voltages	47
17 Block Diagrams	32	18.13. Waveforms	49
17.1. Video Signal Block Diagram	33	19 Parts Location	50
17.2. Audio Signal Block Diagram	34	20 Parts List	51
18 Schematics	35	20.1. Parts List Notes	51
		20.2. Parts List	52

1 Safety precautions

General guidelines

An isolation transformer should always be used during the servicing of a receiver whose chassis is not isolated from AC power line. Use a transformer of adequate power rating as this protects the technician from accidents resulting in personal injury from electrical shocks. It will also protect the receiver from being damaged by accidental shorting that may occur during servicing.

When servicing, observe the original lead dress, especially in the high voltage circuit. Replace all damaged parts (also parts that show signs of overheating.)

Always replace protective devices, such as fish paper, isolation resistors and capacitors, and shields after servicing the receiver. Use only manufacturer's recommended rating for fuses, circuits breakers, etc.

High potentials are present when this receiver is operating. Operation of the receiver without the rear cover introduces danger for electrical shock. Servicing should not be performed by anyone who is not thoroughly familiar with the necessary precautions when servicing high voltage equipment.

Extreme care should be practiced when handling the picture tube. Rough handling may cause it to implode due to atmospheric pressure. (14.7 lbs per sq. in.). Do not nick or scratch the glass or subject it to any undue pressure. When handling, use safety goggles and heavy gloves for protection. Discharge the picture tube by shorting the anode to chassis ground (not to the cabinet or to other mounting hardware). When discharging connect cold ground (i.e. dag ground lead) to the anode with a well insulated wire or use a grounding probe. Avoid prolonged exposure at close range to unshielded areas of the picture tube to prevent exposure to x ray radiation.

The test picture tube used for servicing the chassis at the bench should incorporate safety glass and magnetic shielding. The safety glass provide shielding for the tube viewing area against x ray radiation as well as implosion. The magnetic shield limits the x ray radiation around the bell of the picture tube in addition to the restricting magnetic effects. When using a picture tube test jig for service, ensure that the jig is capable of handling 50kV without causing x ray radiation.

Before returning a serviced receiver to the owner, the service technician must thoroughly test the unit to ensure that is completely safe to operate. Do not use a line isolation transformer when testing.

Leakage current cold check

Unplug the A.C. cord and connect a jumper between the two plug prongs. Measure the resistance between the jumpered AC plug and expose metallic parts such as screwheads, antenna terminals, control shafts, etc. If the exposed metallic part has a return path to the chassis, the reading should be between 240k Ω and 5.2M Ω . If the exposed metallic part does not have a return path to the chassis, the reading should be infinite.

Leakage current hot check

Plug the AC cord directly into the AC outlet. Do not use an isolation transformer during the check.

Connect a 1.5k Ω 10 watt resistor in parallel with a 0.15 μ F capacitor between an exposed metallic part and ground. Use earth ground, for example a water pipe.

Using a DVM with a 1000 ohms/volt sensitivity or higher, measure the AC potential across the resistor.

Repeat the procedure and measure the voltage present with all other exposed metallic parts.

Verify that any potential does not exceed 0.75 volt RMS. A leakage current tester (such a Simpson model 229, Sencore model PR57 or equivalent) may be used in the above procedure, in which case any current measure must not exceed 0.5 milliamp. If any measurement is out of the specified limits, there is a possibility of a shock hazard and the receiver must be repaired and rechecked before it is returned to the customer.

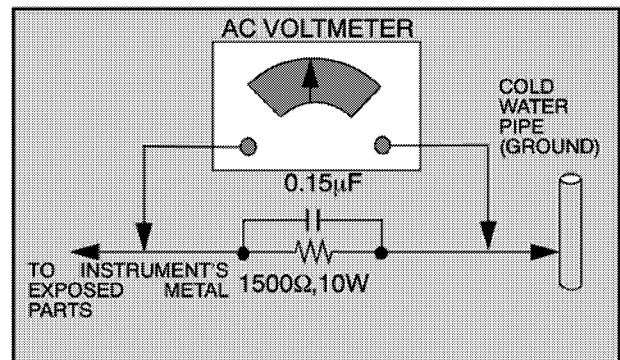

Hot check circuit

Insulation test

Connect an insulation tester between an exposed metallic part and A.C. line. Apply 1080VAC/60Hz for 1 second. Confirm that the current measurement is 0.5mA ~ 2.0mA. Repeat test with other metallic exposed parts.

X ray radiation

WARNING

The potential source of x ray radiation in the TV set is in the high voltage section and the picture tube.

NOTE

It is important to use an accurate, calibrated high voltage meter.

Set the brightness, picture, sharpness and color controls to minimum.

Measure the high voltage. The high voltage should be 27.70 \pm 1.25kV for 20" models and 29.25 \pm 1.25kV for 25" models . If the upper limit is out of tolerance, immediate service and correction is required to insure safe operation and to prevent the possibility of premature component failure.

Horizontal oscillator disable circuit test

This test must be performed as a final check before the receiver is returned to the customer. See horizontal oscillator disable circuit procedure check in this manual.

2 Service notes

NOTE

These components are affixed with glue. Be careful not to break or damage any foil under the component or at the pins of the ICs when removing. Usually applying heat to the component for a short time while twisting with tweezers will break the component loose.

Leadless chip component (surface mount)

Chip components must be replaced with identical chips due to critical foil track spacing. There are no holes in the board to mount standard transistors or diodes. Some chips capacitor or resistor board solder pads may have holes through the board, however the hole diameter limits standard resistor replacement to 1/8 watt. Standard capacitor may also be limited for the same reason. It is recommended that identical components be used.

Chip resistor have a three digit numerical resistance code, 1st and 2nd significant digits and a multiplier. Example: 162 = 1600 or 1.6k Ω resistor, 0 = 0 Ω (jumper).

Chip capacitors generally do not have the value indicated on the capacitor. The color of the component indicates the general range of the capacitance.

Chip transistors are identified by a two letter code. The first letter indicates the type and the second letter, the grade of transistor.

Chip diodes have a two letter identification code as per the code chart and are a dual diode pack with either common anode or common cathode. Check the parts list for correct diode number.

Component removal

1. Use solder wick to remove solder from component end caps or terminal.
2. Without pulling up, carefully twist the component with tweezers to break the adhesive.
3. Do not reuse removed leadless or chip components since they are subject to stress fracture during removal.

Chip component installation

1. Put a small amount of solder on the board soldering pads.
2. Hold the chip component against the soldering pads with tweezers or with a miniature alligator clip and apply heat to the pad area with a 30 watt iron until solder flows. Do not apply heat for more than 3 seconds.

Chip components

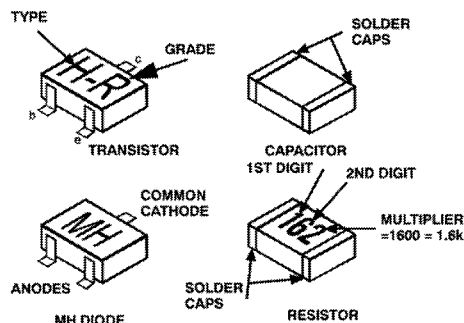

How to replace flat ic (required tools)

1. Remove the solder from all of the pins of a Flat IC by using a desolder braid

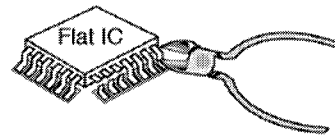

2. Put the iron wire under the pins of the Flat IC and pull it in the direction indicated while heating the pins using a soldering iron. A small awl can be used instead of the iron wire.

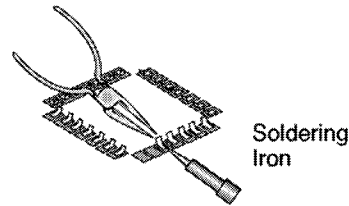

3. Remove the solder from all the pads of the Flat IC by using a de solder braid

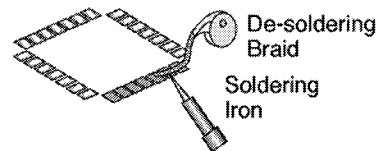

4. Position the new Flat IC in place (apply the pins of the Flat IC to the soldering pads where the pins need to be soldered). Properly determine the positions of the soldering pads and pins by correctly aligning the polarity symbol

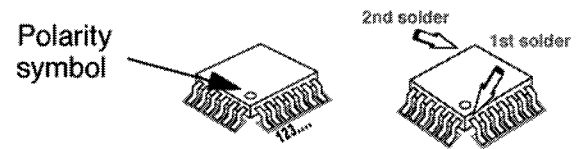

5. Solder all pins to the soldering pads using a fine tipped soldering iron

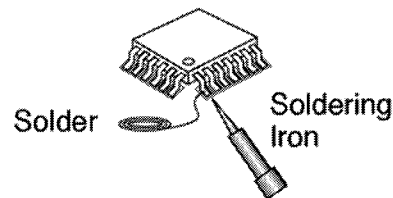

6. Check with a magnifier for solder bridge between the pins or for dry joint between pins and soldering pads. To remove a solder bridge, use a de solder braid as shown in the figure below

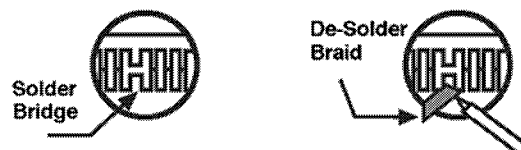

IMPORTANT

To protect against possible damage to the solid state devices due to arcing or static discharge, make certain that all ground wires and CRT DAG wire are securely connected.

CAUTION

The power supply circuit is above earth ground and the chassis cannot be polarized. Use an isolation transformer when servicing the receiver to avoid damage to the test equipment or to the chassis. Connect the test equipment to the proper ground (hot) or (cold) when servicing, or incorrect voltages will be measured.

2.1. X-Ray Protection Circuit Check & Adjustments

This test must be performed as final check before the receiver is returned to the customer. If voltages are out of tolerance, immediate service and correction is required to insure safe operation and to prevent the possibility of premature component failure.

Equipment:

1. Isolation transformer.
2. High voltage meter.
3. D.C. Ammeter
4. Short jumper.
5. HHS jig (See figure below).

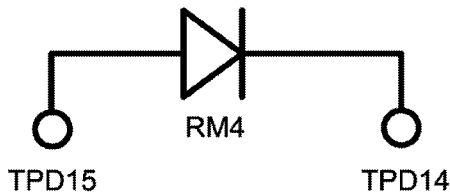

Diode Connection Jumper.

Preparation:

1. Make sure the receiver is turned off.
2. Connect the receiver to an isolation transformer.
3. Connect the ammeter serial from the flyback anode lead to the picture tube anode socket.
4. Prepare short jumper and HHS jig.

Procedure:

1. Connect the short jumper between TPD16 & TPD17.
2. Connect the jumper diode between TPD14 and TPD15 (anode connected to TPD15 and cathode to TPD14).
3. Apply 75VAC to AC input of isolation transformer.
4. Turn the receiver on.
5. Apply a monoscope pattern.
6. Set customer picture and brightness controls to the minimum.
7. tSet current within 50µA to 100µA by changing the picture and bright controls.
8. Slowly increase AC voltage at the input of the isolation transformer and confirm HHS voltage measure **31kV** for 20" models and **33kV** for 25" models.
9. Turn power off and remove jigs.

3 EEPROM replacement

If a new EEPROM integrated circuit is replaced for servicing, follow the next procedure once that the memory is properly assembled:

1. Turn the TV set ON.
2. Enter to service mode.
3. Once inside service mode the first image that appears on-screen is the ID1 register with the respective address value (FF) like the image below.

Note:

All 3 registers (ID1, ID2, ID3) should appear with FF values if a new EEPROM is assembled.

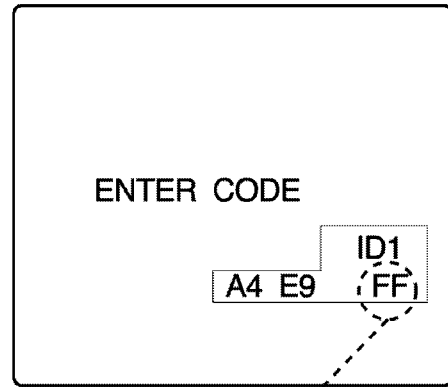

VALUE TO MODIFY

4. With "VOL" keys adjust the correct value according with the service adjustment table (see "Service Mode" section in page 15).
5. Change to the next ID switch register with "CH" keys and repeat the same procedure as step 4.
6. When replacing a new EEPROM be sure to set the correct ID switch values for each model.
7. Once that all 3 registers are set with the correct address value, perform all of the remaining adjustments and servicing.

IMPORTANT:

Correct ID switch configuration should be input when replacing EEPROM for each television model, otherwise if wrong values are configured, the television software will not function accordingly and properly.

4 About lead free solder (PbF)

NOTE

Lead is listed as (Pb) in the periodic table of elements.

In the information below, Pb will refer to lead solder, and PbF will refer to Lead Free Solder.

The lead free solder used in our manufacturing process and discussed below is (Sn+Ag+Cu).

That is Tin (Sn), Silver (Ag) and Copper (Cu) although other types are available.

This model uses Pb Free solder in it's manufacture due to environmental conservation issues. For service and repair work, we'd suggest the use of Pb free solder as well, although Pb solder may be used.

PCBs manufactured using lead free solder will have the "PbF" or a leaf symbol stamped on the back of PCB.



CAUTION

- Pb free solder has a higher melting point than standard solder. Typically the melting point is 50 ~ 70 °F (30 ~ 40 °C) higher. Please use a high temperature soldering iron and set it to 700 ± 20 °F (370 ± 10 °C).
- Pb free solder will tend to splash when heated too high (about 1100 °F or 600 °C).
If you must use Pb solder, please completely remove all of the Pb free solder on the pins or solder area before applying Pb solder. If this is not practical, be sure to heat the Pb free solder until it melts, before applying Pb solder.
- After applying PbF solder to double layered boards, please check the component side for excess solder which may flow onto the opposite side.

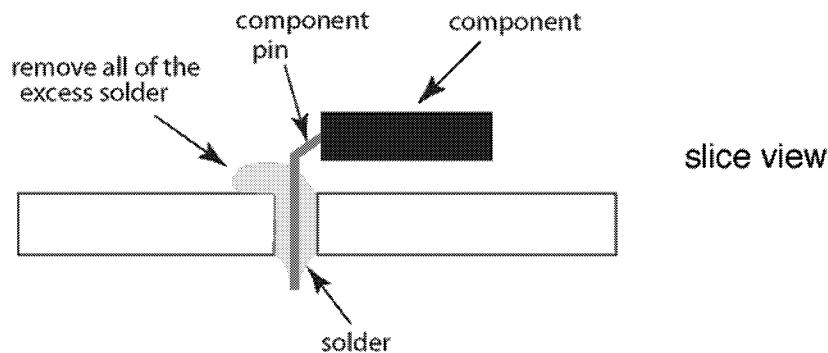

Suggested Pb free solder

There are several kinds of Pb free solder available for purchase. This product uses Sn+Ag+Cu (tin, silver, copper) solder. However, Sn+Cu (tin, copper), Sn+Zn+Bi (tin, zinc, bismuth) solder can also be used.

0.3mm X 100g	0.6mm X 100g	1.0mm X 100g

5 Receiver feature table

FEATURE/MODEL	CT-25L8G/UG	CT-20L8G	CT-20G8G/SG
CHASSIS	AP403	BP398	AP398
MICRO	128K		
MENU LANGUAGE	ENG/SPAN/FR		
CLOSED CAPTION	X		
V-CHIP (USA/CANADA)	X		
CHANNEL COUNT	181		
REMOTE CONTROL	EUR7713010		
CRT SUPPLIER	PANABLACK, SAMSUNG		
CHASSIS	NA10		
COMB FILTER	DIGITAL		
V/A NORM (X=BOTH)	V		
MTS/SAP/DBX	X		
BUILT-IN AUDIO POWER	1.5Wx2 (10%)		
No. OF SPEAKERS	2		
AI SOUND	X		
A/V IN (REAR/FRONT)	2(2/1)		1(1/1)
COMPONENT INPUT (Y, Pb, Pr)	1	----	
S-VIDEO INPUT (REAR/FRONT)	2/1	1/0	

Note:

Specifications are subject to change without notice or obligation. Dimensions and weights are approximate.

6 Board description table

CT-20G8/CT-20G8S

BOARD	PART NUMBER	DESCRIPTION
A	TNP2AH047AA	MAIN BOARD
C	TNP2AA122AA	CRT BOARD

CT-20L8G

BOARD	PART NUMBER	DESCRIPTION
A	TNP2AH047AB	MAIN BOARD
C	TNP2AA122AA	CRT BOARD

CT-25L8G/CT-25L8UG

BOARD	PART NUMBER	DESCRIPTION
A	TNP2AH047FA	MAIN BOARD
C	TNP2AA122FA	CRT BOARD

NOTE

When ordering a replacement board assembly, append an "S" to the board number

EXAMPLE

To order the A Board, the replacement board is TNP2AH047AAS.

7 TV Location of controls

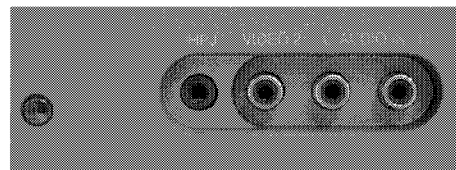
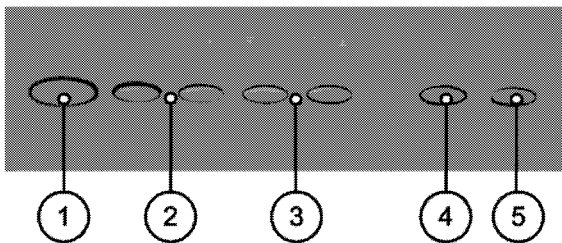

IR Sensor
& Front AV jacks

Quick reference control operation

- 1 **Power** - Press to turn ON or OFF.
- 2 **Volume** - Press to adjust sound level, or to adjust audio menus, video menus, and select operating features when menus are displayed
- 3 **Channel** - Press to select programmed channels. Press to highlight desired features when menus are displayed. Also use to select cable converter box channels after programming remote control infra-red codes (the TV/AUX/CABLE switch must be set in CABLE position).
- 4 **Action** - Press to display main menu and access on screen feature and adjustment menus.
- 5 **TV/Video** - Press to select TV or one of the video inputs, for the main picture or the PIP frame (when PIP frame is displayed).

8 Location of controls (EUR7713010 remote)

POWER

Press to turn ON and OFF.

VOL

Press to adjust TV sound and navigate in menus.

MUTE

Press to mute sound.

KEYBOARD

Press to select any channel.

R-TUNE

Press to switch to previously viewed channel or video mode.



SAP

Press to access the secondary audio program broadcast.

CH

Press to select next or previous channel and navigate in menus.

TV/VIDEO

Press to select TV, Video mode.

RECALL

Press to display time, channel sleep timer and other options.

Note:

For additional information about this remote please refer to the owner's manual section remote operation, listed on the parts list section.

9 Dissassembly for service

Back cover

Remove all the screws marked with an arrow (←) from the back of the receiver

NOTE

Screw configuration, type, and number of screws vary depending on the model of the receiver serviced and the application; variou's models are covered in this manual. Use same hardware when reassembling the receiver.

- 3 screws at the top edge of the receiver (for 25" sets).
- 2 screws at the top edge of the receiver (for 20" sets).
- 1 screw by the A/V jacks.
- 1 screw at each lower corner of the receiver.
- 1 screw by the Flyback.

A-Board - Main chassis

1. Slide the chassis completely out of the guide rails.
2. Stand the receiver on its edge. The underside of the board is completely accessible for component replacement.

Note:

Some tie-wraps that secure the wire dressings may need to be unfastened for chassis removal.

C-Board - CRT output

The board plugs onto the socket on the CRT neck. To release the Focus wire, use a dull object to release the tab on the socket (near the wire opening) and carefully pull on the wire. To connect the focus wire, press on the tab to lock it then insert the wire in the opening and press on it until it is fully inserted and locked in place.

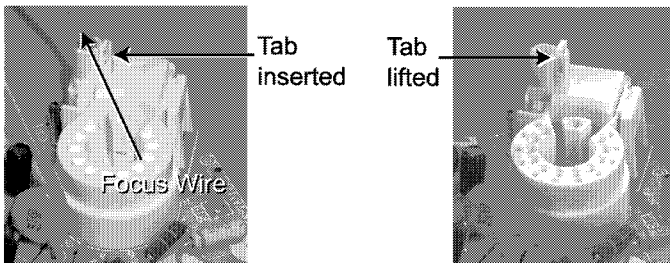

Focus cable release

Speakers

Each speaker is secured to the cabinet with 4 screws.

NOTE

When reassembling speakers be sure to connect the speaker wires to the correct speaker lead (+) (-)

9.1. Disassembly for CRT replacement

1. Discharge the CRT as instructed in the "safety precautions".
2. Disconnect the yoke (DY) plug, degaussing coil (DEG) plug from the main board.
3. Unplug the CRT 2nd anode button from the main board.
4. Remove the C-Board from the CRT base and unplug the black wires (CRT dag ground) C10 & C11.

5. Disconnect the speakers plug from the A-Board.

6. Lift the main chassis (A-Board) and all mounted boards completely out with the CRT board attached.

7. Perform complete removal of chassis, as instructed in "disassembly for service" section.

CRT replacement

1. Perform "disassembly for CRT replacement" procedure.
2. Insure that the CRT H.V. Anode button is discharged before handling the CRT. Read the "safety precautions" section on handling the picture tube.
3. Remove the components from the CRT neck and place the cabinet face down on a soft pad.
4. Note the original order for the CRT mounting hardware as they are remove from the CRT mounting brackets at each corner of the CRT.
5. Remove the CRT with the degaussing coil and the dag ground braid attached.
6. Note the original locations and mounting of the degaussing coil and the dag ground assembly to insure proper reinstallation on the replacement CRT.

To remove and remount the degaussing coil:

- Unhook the coil spring from the bottom corners of the CRT ears.
 - Release the braid loop from the upper corners of the CRT ears.
7. Mount the dag ground braid on the replacement CRT. Position the degaussing coil with new ties. Dress coil as was on the original CRT.
 8. Replace the components on CRT neck and reinstall into cabinet. Verify that all ground wires and circuit board plugs get connected.

IMPORTANT NOTICE

When ordering the CRT, please order CRT and CRT kit also. Please see parts list section for part numbers

10 Chassis service adjustment procedures

All service adjustments are factory preset and should not require adjustment unless controls and/or associated components are replaced.

Note:

Connect the (-) lead of the voltmeter to the appropriate ground. Use IC801's heat sink when the HOT ground symbol is used. Otherwise, use COLD ground (Tuner shield, IC451's heat sink or FA2).

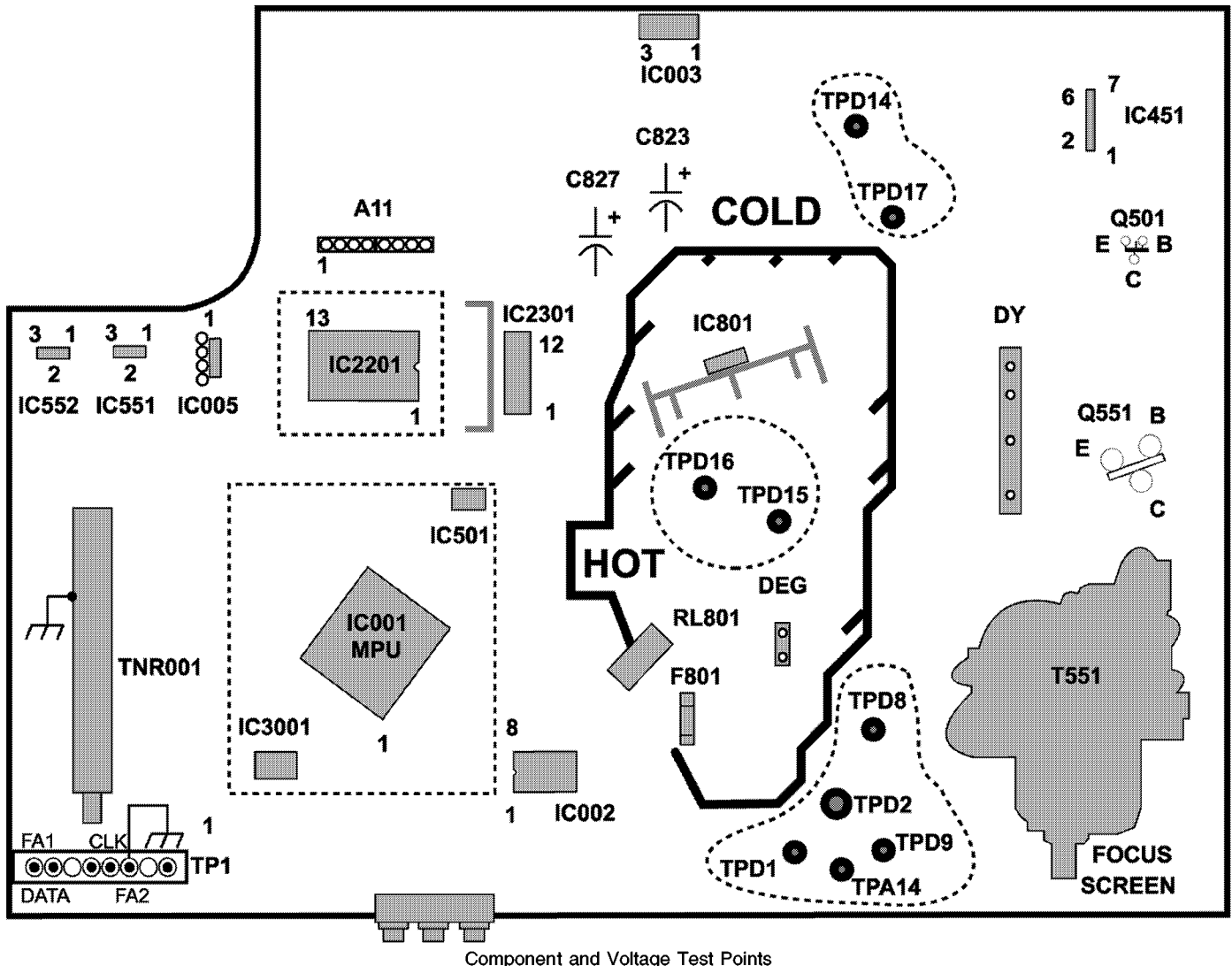

Component and Voltage Test Points

Note:

Components and test points within dotted areas are located on trace side.

B+ voltage check

1. Set the BRIGHT and PICTURE to minimum by using the PICTURE menu.
2. Connect the DVM between C825 (+) side) or TPD14 and cold ground.
3. Confirm that B+ voltage is $131.0V \pm 2.0V$. This voltage supplies B+ to the horizontal output and flyback circuits.

Source voltage chart

120V AC line input. Set the BRIGHT and the PICTURE to minimum by using the PICTURE menu. Use cold or hot ground for the (-) lead of the DVM as needed.

A-BOARD	TEST POINT	VOLTAGE 20"	VOLTAGE 25 "
+B2	TPD14	$131.0 \pm 2.0V$	$131.0 \pm 2.0V$
SOUND	C823 (+)	$18.4 \pm 1.0V$	$18.4 \pm 1.0V$
STB12V	C827 (+)	$12.7 \pm 1.0 V$	$12.7 \pm 1.0 V$

A-BOARD	TEST POINT	VOLTAGE 20"	VOLTAGE 25 "
220V	TPA14	$217 \pm 10 V$	$221 \pm 10 V$
VERTICAL	TPD8	$23.7 \pm 1.5V$	$27.1 \pm 1.5V$
9V	IC551 pin 3	$9.0 \pm 0.5V$	$9.0 \pm 0.5V$
5V	IC552 pin 3	$5.0 \pm 0.5V$	$5.0 \pm 0.5V$
3.3V	IC005 pin 2	$3.3 \pm 0.3V$	$3.3 \pm 0.3V$
EHT	CRT anode	$27.70 \pm 1.25kV$	$29.25 \pm 1.25kV$
HEATER	JK351 H-HGND	$6.3 \pm 0.24V$	$6.3 \pm 0.24V$

High voltage check

1. Select an active TV channel and confirm that horizontal is in sync.
2. Adjust BRIGHTNESS and CONTRAST using PICTURE icon menu so video just disappears.
3. Using a high voltage meter confirm that the high voltage is $27.70 \pm 1.25kV$ for 20" models and $29.25 \pm 1.25kV$ for 25" models.

11 Purity and convergence procedure

Adjustment is necessary only if the CRT or the deflection yoke is replaced or if the setting was disturbed. The complete procedure consists of:

1. Vertical raster shift adjustment.
2. Initial static convergence.
3. Setting the purity.
4. Final static convergence.

WHEN THE CRT OR THE YOKE IS REPLACED

For 2 piece assembly:

Position purity/convergence assembly as shown and tighten clamp snugly. Remove the hot-melt glue seal on assembly and position like tabs of purity device together at 12 o'clock to reduce its magnetic field effect.

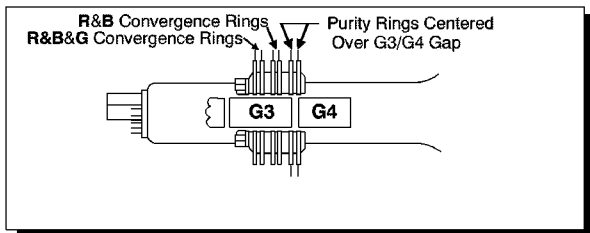

2 piece assembly

For models using 4 pairs of rings, place the yoke on the CRT neck (do not tighten the clamp). Place the vertical raster shift tabs at 3 o'clock (90° from the purity and convergence tabs).

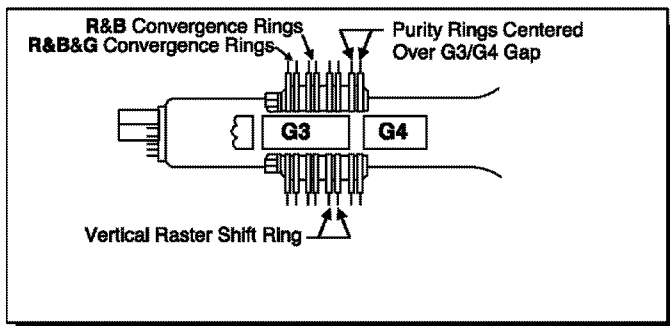

Description of rings

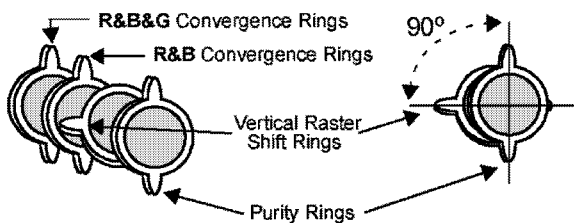

Initial position of rings

Turn the receiver ON. Operate the receiver for 60 minutes using the first purity check field (white screen) to stabilize the CRT.

Fully degauss the receiver by using an external degaussing coil.

Slide the deflection yoke back and forth on the neck of the CRT until it produces a near white, uniform raster.

VERTICAL RASTER SHIFT ADJUSTMENT

Apply a green pattern with a horizontal line, adjust the Deflection Yoke so that has no tilt, then secure it.

Adjust center line of the pattern with the mechanical center of the CRT, this center is determined by two marks at the side edges of the screen. To adjust the line, once the vertical raster shift tabs are placed at 3 o'clock to reduce its magnetic field effect open the tabs the same angle from the center, until the center line of the pattern becomes a straight line, centered with the marks of the CRT.

IMPORTANT NOTICE

Rings come along with deflection yoke in one piece.

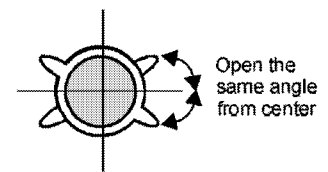
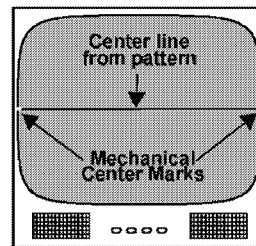

Vertical raster shift tabs

Vertical raster shift adjustment

INITIAL CENTER STATIC CONVERGENCE

Connect a dot/cross hatch generator to the receiver and tune in a signal. Observe misconvergence at center of the screen only.

Adjust the R&B pole magnets; by separating tabs and rotating to converge blue with red.

Adjust the R&B and R&B&G pole magnets: by separating tabs and rotating to converge blue and red (magenta) with green.

NOTE

Precise convergence at this point is not important.

PURITY ADJUSTMENT

When the receiver is in the serviceman mode for making electronic adjustments, press the RECALL button on the remote control to enter purity check. (See the service adjustments electronic controls procedure).

Operate the receiver for 60 minutes using the first purity check field (white screen) to stabilize the CRT.

Fully degauss the receiver by using an external degaussing coil.

Press the RECALL button on the remote control again until the purity check (green screen) appears.

Loosen the deflection yoke clamp screw and move the deflection yoke back as close to the purity magnet as possible.

Adjust the purity rings to set the vertical green raster precisely at the center of the screen.

NOTES:

1. CRT warm up with white screen (three guns activated) is needed to stabilize the shadow mask expansion.
2. Initial center static convergence (roughly centers three gun beams) is required in order to perform purity adjustment.

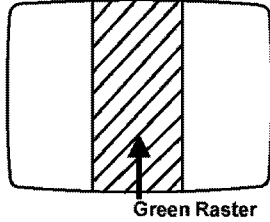

Green raster adjustment

Slowly move the deflection yoke forward until the best overall green screen is displayed.

Tighten the deflection yoke clamp screw.

Press the RECALL button on the remote control again until the purity check blue and red screens appear and observe that good purity is obtained on each respective field.

Press the RECALL button on the remote control again until purity check (white screen) appears. Observe the screen for uniform white. If purity has not been achieved, repeat the above procedure.

FINAL CONVERGENCE PROCEDURE

NOTE

Vertical size and focus adjustments must be completed prior to performing the convergence adjustment. Connect a dot pattern generator to the receiver. The brightness level should not be higher than necessary to obtain a clear pattern.

Converge the red and the blue dots at the center of the screen by rotating the R&B pole static convergence magnets.

Align the converged red/blue dots with the green dots at the center of the screen by rotating the R&B&G pole static convergence magnets. Melt wax with soldering iron to reseal the magnets.

Slightly tilt vertically and horizontally (do not rotate) the deflection yoke to obtain a good overall convergence.

If convergence is not reached at the edges, insert permalloy in the DY corners to achieve proper convergence. Recheck for purity and readjust if necessary.

After vertical adjustment of the yoke, insert wedge at 11 o'clock position, then make the horizontal tilt adjustment.

Secure the deflection yoke by inserting four side wedges.

Apply adhesive between tab (thin portion) of wedge and CRT and place tape over the tab to secure to the CRT.

11.1. Permalloy convergence corrector strip (Part No. 0FMK014ZZ)

This strip is used in some sets to match the yoke and CRT for optimum convergence. If the yoke or CRT is replaced, the strip may not be required.

First converge the set without the strip and observe the corners.

First converge the set without the strip and observe the corners.

If correction is needed:

1. Place strip between CRT and yoke, in quadrant needing correction. Slowly move it around for desired results.
2. Press adhesive tightly to the CRT and secure with tape.

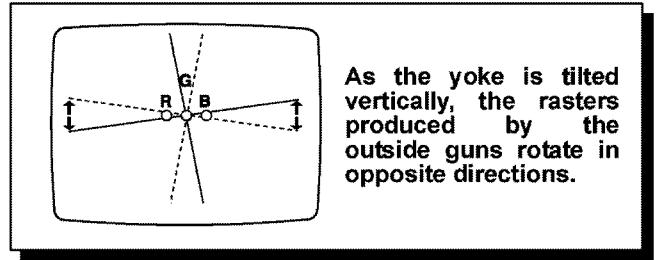

Vertical Yoke Movement

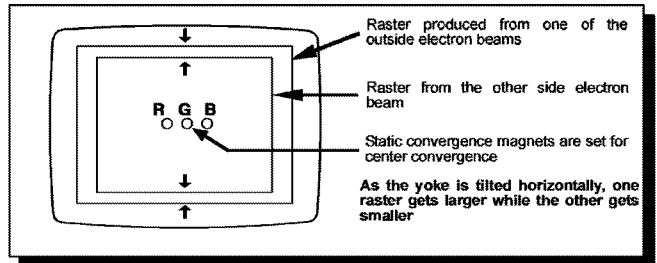

Horizontal Yoke Movement

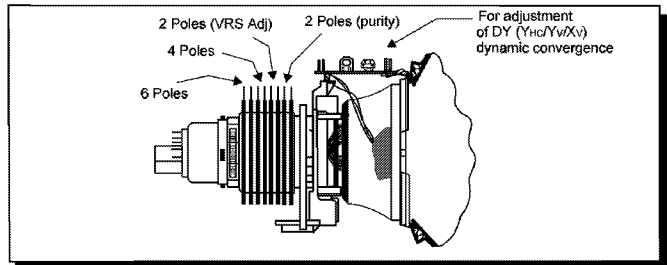

Convergence Magnets and Wedges Location

12 Service mode (electronic adjustments)

This receiver has electronic technology using the IC bus concept. It performs as a control function and it replaces many mechanical controls. Instead of adjusting mechanical controls individually, many of the control functions are now performed by using "on screen display menu". (The service adjustment mode).

NOTE

It is suggested that the technician reads all the way through and understand the following procedure for entering/exiting the service adjustment mode; then proceed with the instructions working with the receiver. When becoming familiar with the procedure, the flow chart for service mode may be used as a quick guide.

Quick entry to service mode

When minor adjustments need to be done to the electronic controls, the method of entering the service mode without removal of the cabinet back is as follows using the remote control:

1. Select SET-UP icon and select CABLE mode.
2. Select TIMER icon and set SLEEP time for 30 Min.
3. Press "ACTION" twice to exit menus.
4. Tune to the channel 124.
5. Adjust VOLUME to minimum (0).
6. Press VOL → (decrease) on receiver. Red "CHK" appears in upper corner.

To toggle between aging and service modes:

While the "CHK" is displayed on the left top corner of the CRT, pressing "ACTION" and "VOL" UP on the TV simultaneously will toggle between the modes. Red "CHK" for service and yellow "CHK" for aging.

7. Press POWER on the remote control to display the service adjustment modes menu, select adjustment by pressing the volume right/left buttons and channel up/down buttons on the remote and ACTION to enter the adjustment.

MTS	MTSIN	SEPAL	SEPAH	
CLOCK	CLOCK			HHSTH
VIDEO	COLOR	TINT	BRIGH	CONT
	B-Y_G	CUT_G	CUT_R	CUT_B
	BRT	R-DR	B-DR	
HDEF		H POS		
VDEF	VEAMP	V-C	V-S	VPOS
SETID	ID1	ID2	ID3	

Exiting the service mode:

This TV goes out from service mode when it is unplugged or turned OFF. To exit the service mode, turn the TV OFF from or unplug the TV from A.C.

Other method

Press ACTION and POWER on the receiver simultaneously for at least 2 seconds.

The receiver momentarily shuts off; then comes back on tuned to channel 3 with a preset level of sound.

Any programmed channels, channels caption data and some others user defined settings will be erased when

exited by pressing ACTION and POWER on receiver.

IMPORTANT NOTE

Always check that the TV exits the service mode.

To confirm colors

When in service mode (red "CHK" is displayed) press RECALL on the remote control to enter the purity field check mode

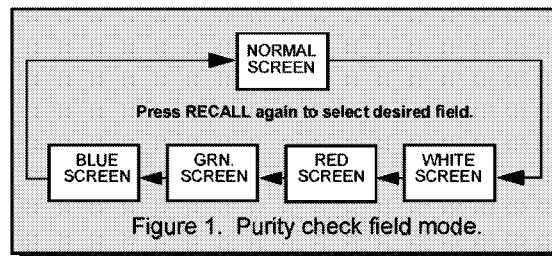

Entering service mode (open-back method)

While the receiver is connected and operating in normal mode, momentarily short test point FA1 (TP1 pin 2) to cold ground (TP1 pin 3).

The receiver enters the aging mode.

Yellow letters "CHK" appear in the upper left corner of the screen.

(The volume right/left and channel up/down will adjust rapidly).

Note:

If service mode is accessed by this method be sure to reset the set after service is performed.

12.1. Service adjustment default values for items

NAME	DESCRIPTION	ADDRESS	REGISTER VALUE		
			CT-20G8G/SG	CT-20L8G	CT-25L8G/UG
MTSIN	MTS INPUT LEVEL	A4 01	25	25	25
SEPAL	MTS LOW LEVEL SEPARATION	A4 02	08	08	08
SEPAH	MTS HIGH LEVEL SEPARATION	A4 03	1D	1D	1D
CLOCK	CLOCK	A4 04	128	128	128
HHSTH	HHS VOLTAGE LEVEL REFERENCE	A4 05	9D	9D	89
COLOR	COLOR	A4 06	01 15	01 15	01 15
TINT	TINT	A4 08	56	56	56
BRIGH	SUB-BRIGHTNESS	A4 09	4E	4E	40
CONT	SUB-CONTRAST	A4 0A	38	38	60
B-Y_G	MAGENTA TINT ADJ	A4 0B	80	80	80
CUT_G	GREEN CUT-OFF	A4 0C	01 C3	01 C3	02 05
CUT_R	RED CUT-OFF	A4 0E	02 0E	02 0E	02 9B
CUT_B	BLUE CUT-OFF	A4 10	01 5B	01 5B	01 F4
BRT	BRIGHT	A4 12	4E	4E	40
R-DR	RED DRIVE	A4 13	09 00	09 00	08 86
B-DR	BLUE DRIVE	A4 15	09 00	09 00	07 ED
H-POS	HORIZONTAL POSITION	A4 18	82	82	73
VEAMP	VERTICAL SIZE	A4 29	9B	9B	9C
V-C	VERTICAL LINEARITY	A4 2A	4C	4C	4C
V-S	VERTICAL SIZE CORRECTION	A4 2B	00	00	00
VPOS	VERTICAL POSITION	A4 FF	7C	7C	77
ID1*	ID SWITCH 1	A4 E9	88	70	70
ID2*	ID SWITCH 2	A4 EA	06	06	06
ID3*	ID SWITCH 3	A4 EB	30	30	30

IMPORTANT:

These table values are approximated and could change due to variation of electrical characteristics in each set, except for the ID switch values.

*Note:

The correspondent ID switch (ID1, ID2, ID3) data configuration should not be modified in any way. If EEPROM circuit needs to be replaced, these ID values should be configured according with this table.

12.2. Instructional Flow Chart for Service Mode

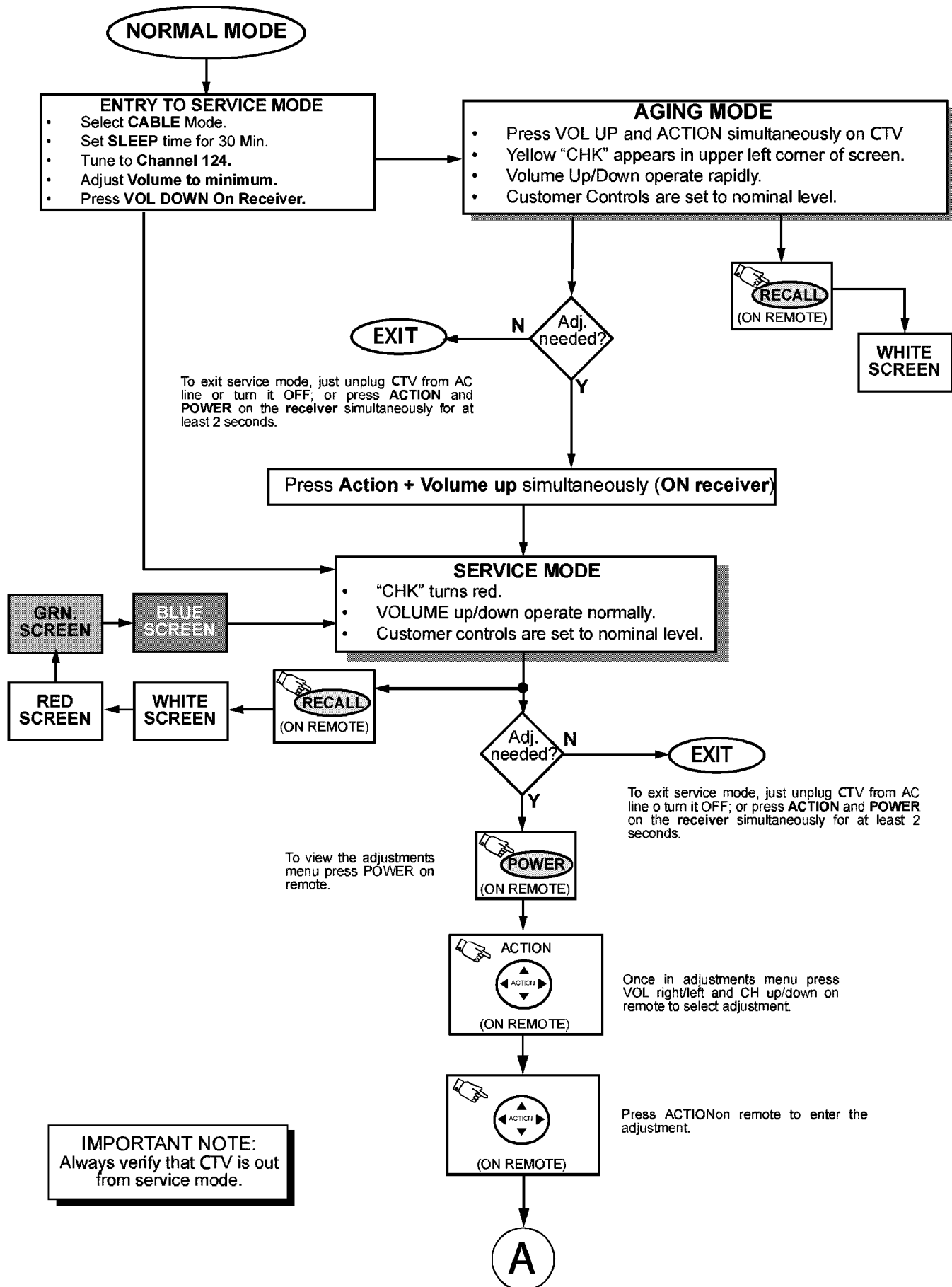

12.3. Instructional flow chart for service mode (continued).

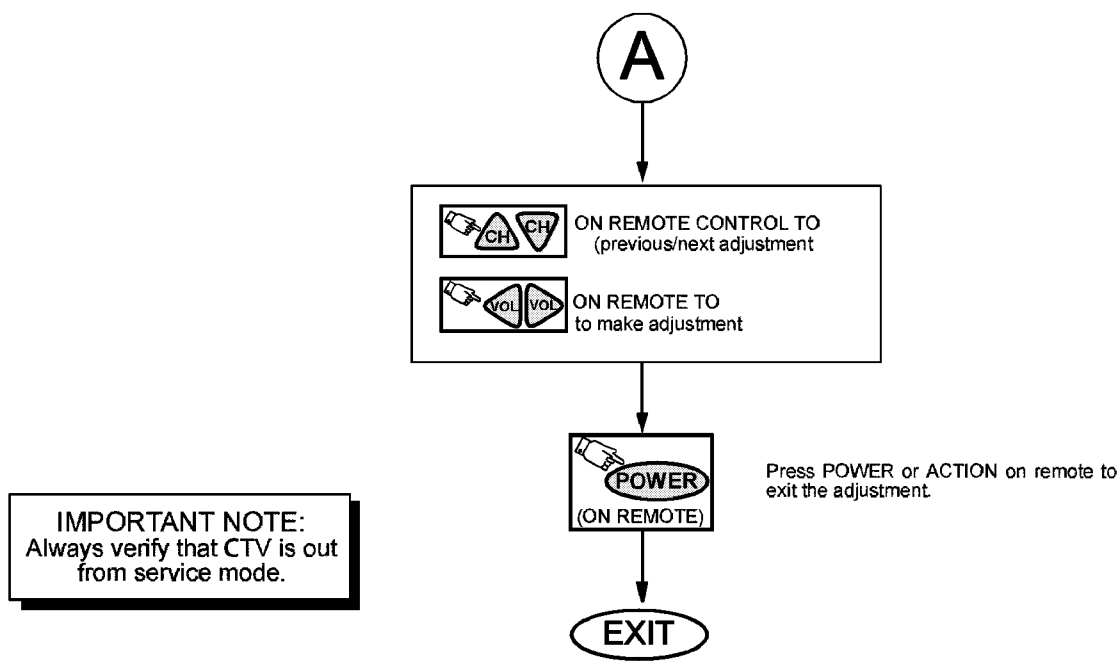

To exit service mode, just unplug CTV from AC line or turn it OFF; or press ACTION and POWER on the receiver simultaneously for at least 2 seconds.

13 Service adjustments (electronic controls)

NOTE

Please correlate with available pattern on all adjustments

13.1. Sub-Brightness and Contrast Service DAC adjustment (BRIGH, CONT)

Adjustment of this control is important for setting proper operation of customer brightness and picture controls. Do not adjust the SCREEN VR after the sub-brightness is set.

This adjustment is factory set. Do not adjust unless repairs are made to associated circuit, the CRT Board or when the CRT is replaced.

Preparation

1. Apply a colorbar pattern.
2. Set the PICTURE control to the maximum.
3. Set COLOR control to minimum (no color on picture).
4. Set the BRIGHTNESS control to the center.
5. Set the SHARPNESS control to the center.
6. Connect the oscilloscope to TP35.

Procedure

1. In the service mode, select DAC for brightness adjustment "BRIGH", and adjust data to obtain $3.8 \pm 0.1V$ (for 20" CRT) or $3.4 \pm 0.1V$ (for 25" CRT) between 7.5IRE and GND level at TP35. (See waveform detail).
2. In service mode, select DAC for contrast adjustment "CONT", and adjust data to obtain $2.2 \pm 0.1V$ (for 20" CRT) or $2.7 \pm 0.1V$ (for 25" CRT) between 7.5IRE and 100IRE level at TP35. (See waveform detail).

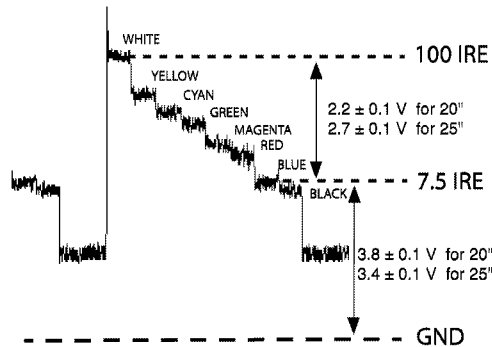

13.2. Color output adjustment Service DAC adjustment (COLOR, TINT)

NOTE

if a rainbow pattern generator is available perform the following procedure; the next section describes the procedure with no rainbow pattern.

Make sure that sub-contrast adjustment was finished prior to perform this adjustment.

PREPARATION

1. Normalize the picture settings.

2. Set the BRIGHTNESS control to minimum.
3. Set the COLOR control to the center.
4. Set the TINT control to the center.
5. Set the PICTURE control to the maximum.
6. Set the SHARPNESS control to the minimum.

PROCEDURE

1. Apply a rainbow color bar pattern.
2. Connect the oscilloscope to TP37.
3. In service mode adjust "TINT" register until the waveform measured is as the one shown. Tint level from A and B peaks must be almost in the same level ($0.3 V_p$ for 20" models and $0.35 V_p$ for 25" models).

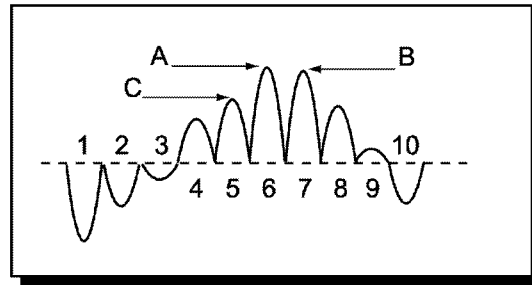

TP37 Waveform.

4. Connect the oscilloscope to TP35 and GND.
5. Adjust "COLOR" register so that the amplitude "a" is $0.8 \pm 0.05V_{p-p}$ for 20" models and amplitude "b" $0.9 \pm 0.05V_{p-p}$ for 25" models.

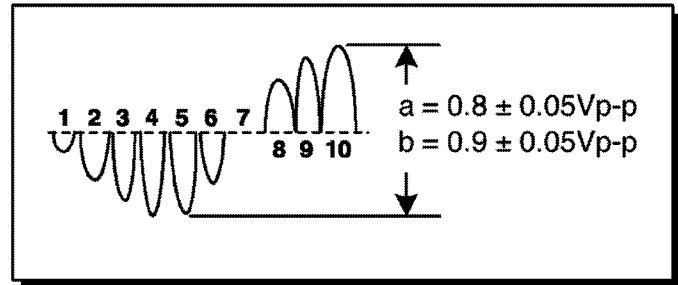

TP35 Waveform.

13.3. Color output adjustment Service DAC adjustment (COLOR, TINT, B-Y_G)

NOTE

Color and tint adjustment sets the reference settings for the user controls; It is important to read the procedures.

(NO RAINBOW PATTERN)

Make sure that sub-contrast adjustment was finished prior to perform this adjustment

PREPARATION

Normalize the picture settings.

PROCEDURE

1. Apply a color bar pattern.
2. In service mode adjust "R DR" and "B DR" data to "80".
3. In service mode adjust "TINT" data so that the color

does not become greenish or redish.

4. In service mode adjust "COLOR" data so that the color level is not too high (saturated) or too low (tending to black and white).
5. In service mode adjust "B-Y G" data so that blue and green seem natural.
6. Confirm that saturation and picture are normal (normal image).
7. If image is not satisfactory, repeat adjustment until the image is normal and natural.

NOTE

The image can be compared against other set to see the image quality.

13.4. Color temperature adjustment (B/W Tracking) Service DAC Adjust. (CUT R) (CUT G) (CUT B) (R DR) (B DR)

Minor Touch-Up Method

OBSERVE low and high brightness areas of a B/W picture for proper tracking. Adjust only as required for "good gray scale and warm highlights".

1. LOW LIGHT areas - In service mode for making electronic adjustments, select CUT R, CUT G, CUT B and adjust the picture for gray.
2. HIGH LIGHT areas - In service mode for making electronic adjustments, select drive R DR, B DR and adjust the picture for warm whites.

Complete adjustment

PREPARATION

1. Turn the receiver "ON" and allow 30 minutes warm up at WHITE PATTERN.
2. Apply a color bar pattern (with no color).
3. Turn the SCREEN control (part of FBT T551) fully counterclockwise.
4. Preset the following service DACs for best results:
 - BRIGH _____ 1 D0
 - CUT R _____ 02 00
 - CUT G _____ 02 00
 - CUT B _____ 02 00
 - R DR _____ 07 FF
 - B DR _____ 07 FF

PROCEDURE

1. Connect the oscilloscope to KG (CRT-Board).
2. In service mode for making electronic adjustment, select "BRIGH" DAC.
3. Press RECALL button on the remote control to collapse the raster. (service SW).
4. Connect oscilloscope to KG on C-Board and adjust service mode "CUT-G" DAC until $170 \pm 2V$ above DC ground is measured
5. Remove the probe from KG.
6. Turn screen clockwise slowly until color is slightly

appeared.

7. Then adjust "CUT R" and "CUT B" until line becomes white.
8. Press RECALL button on the remote to restore the raster.
9. Adjust "R DR" and "B DR" so the white seems like white and black like black.
10. Apply a normal signal and confirm that the image is normal and a good gray scale
11. If correction is needed perform minor touch-up method.

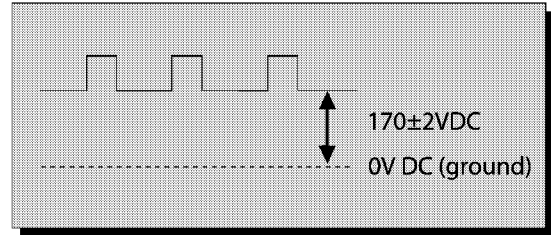

13.5. Deflection adjustments

To reset deflection adjustments

To reset deflection adjustments to factory adjusted default, enter to service mode (with red CHK displayed), press POWER button on remote to display the service menu, then press and hold RECALL button for at least three seconds, a reset message will appear in the image.

Use this feature when deflection adjustment gets off adjustment to the point that it cannot be adjusted back easily.

13.5.1. H-Center adjustment

PREPARATION

1. Apply a crosshatch pattern.
2. Normalize the picture settings.

PROCEDURE

1. Apply a monoscope pattern to center the picture.

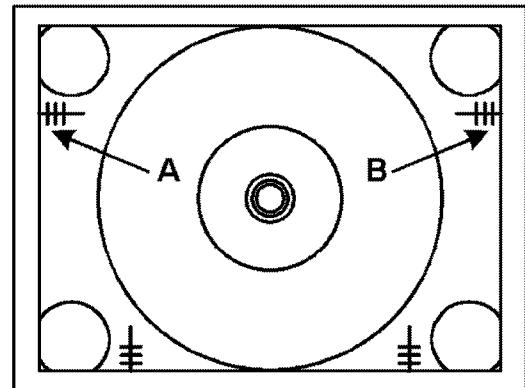

Horizontal Center Adjustment

2. If the horizontal center is not aligned, in service mode adjust "H POS" DATA to adjust the horizontal center of the monoscope pattern to the CRT center.
3. Verify that horizontal width (A & B mark) is within 4.5 ± 0.7 for 20" models and 5.0 ± 0.7 for 25" models.

13.5.2. Vertical linearity(V-C), V-Size and V-Position adjustment

PREPARATION

1. Apply a crosshatch pattern
2. Normalize the picture settings.

PROCEDURE

1. Enter service mode, select DAC adjustment "V-POS" and adjust monoscope pattern to the center vertical position of the CRT center mark.
2. Adjust linearity data "V-C" so that interval of "a" is same as "b" (a=b).

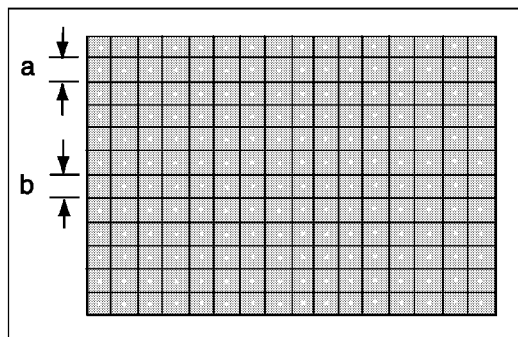

V-Adjustment

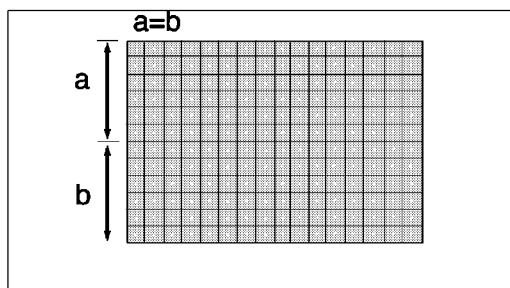

3. If the v-position is not at the CRT center, adjust V position "V POS" DATA again.
4. Apply a monoscope pattern.
5. Confirm that center horizontal line is in center mark on CRT.
6. Adjust "VEAMP" register for correct vertical size by making monoscope round circle leaving 4 marks off the CRT edge.

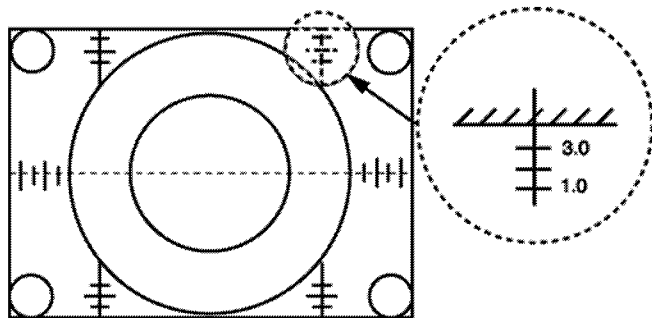

Vertical centering adjustment.

13.5.3. V-S Correction adjustment

PREPARATION

1. Apply a crosshatch pattern
2. Normalize the picture settings.

PROCEDURE

1. Enter to service mode
2. Check a and b sizes, If $b-a < -1.5\text{mm}$ (in top & bottom extending case)
 - Increase "V-S" DATA by one step

NOTE

Repeat "a" and "b" until $b-a \pm 1.5\text{mm}$

3. Confirm to make outermost circle of monoscope pattern a correct circle

13.6. MTS circuit adjustments

The MTS circuit adjustments require two steps:

1. Input level adjustment.
2. Stereo separation adjustment.

Input level adjustment

Service DAC adjustment (MTSIN)

PREPARATION

1. Connect an RMS meter with filter jig as shown in figure to TPE11.

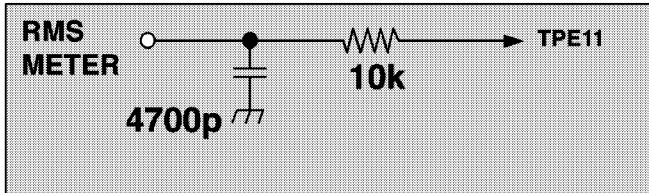

Filter Jig

2. Connect an RF signal generator to the RF antenna input.

PROCEDURE

1. Apply the following signal from the RF signal generator:
 - Video: 100 IRE flat field, 30% modulation.
 - Audio: 300Hz, 100% modulation, monaural (70 ±5dB, 75Ω OPEN, P/S 10dB). Make sure that the 75µs pre-emphasis is OFF.
2. Adjust the MTS input level adjustment "MTSIN" data until the RMS voltage measured is 106 ± 6.0mVrms.

Stereo separation adjustment (SEPAH)

PREPARATION

1. Connect an R.F. signal generator to the RF antenna input.
2. Connect a scope to TPA20.

PROCEDURE

1. Select stereo mode in audio menu
2. Apply the following signal from the RF signal generator:
 - Video: 100 IRE flat field, 30% modulation.
 - Audio: 300Hz, 30% modulation, stereo (left only) (70±5dB, 75Ω OPEN, P/S 10dB).

NOTE

After setting 30% modulation with P.L. SW and N.R. SW OFF, turn P.L. SW and N.R. SW ON.

3. In service mode, adjust the MTS Low-Level separation adjustment "SEPAL" data until the amplitude displayed on the scope is minimum.
4. Apply the following signal from the RF signal generator:
 - Video: 100 IRE flat field, 30% modulation
 - Audio: 3KHz, 30% modulation, stereo (left only)

(70 ±5dB, 75Ω OPEN, P/S 10dB).

NOTE

After setting 30% modulation with P.L. SW and N.R. SW OFF, turn P.L. SW and N.R. SW ON.

5. Adjust the MTS High-level separation adjustment "SEPAH" until the amplitude displayed on the scope is minimum.
6. Repeat above steps 2 through 5 until the amplitude is at minimum for both signals.

13.7. Clock adjustment (CLOCK)

PREPARATION

Connect the frequency counter from TP017 (IC001 pin 79) to cold ground

PROCEDURE

1. Turn the receiver "OFF" with the A.C. power applied.
2. Measure TP017 (IC001 pin 79) for the frequency of the waveform and record the reading.

NOTE

3. TP017 (IC001 pin 79) measurement must have at least four digits of resolution following the decimal point. Example: 000.0000
4. Place the receiver into service mode for making electronic adjustment, select the clock adjustment DAC "CLOCK".
5. Calculate and set "CLOCK" based on the following formula:

$$\text{CLOCK} = 128 - \left[\frac{(\text{TP017}_{freq} - 610.35)}{610.35} \times 450000 \right]$$

NOTE

TP017 (IC001 pin 79) measurement will not change regardless of the value stored in CLOCK.

13.8. Service Adjustments Mechanical Controls

WIDTH CORRECTION ADJUSTMENT

Note

Perform this adjustment only when FBT is changed.

FOCUS (PART OF T551)

Preparation

Apply a crosshatch pattern with dots.

Procedure

1. Adjust the FOCUS VR to obtain the sharpest and clearest dot pattern.
 - Adjust for best center.
 - Adjust for best area between the center and top right corner.

14 Identification of Components

14.1. Back Cover Removal

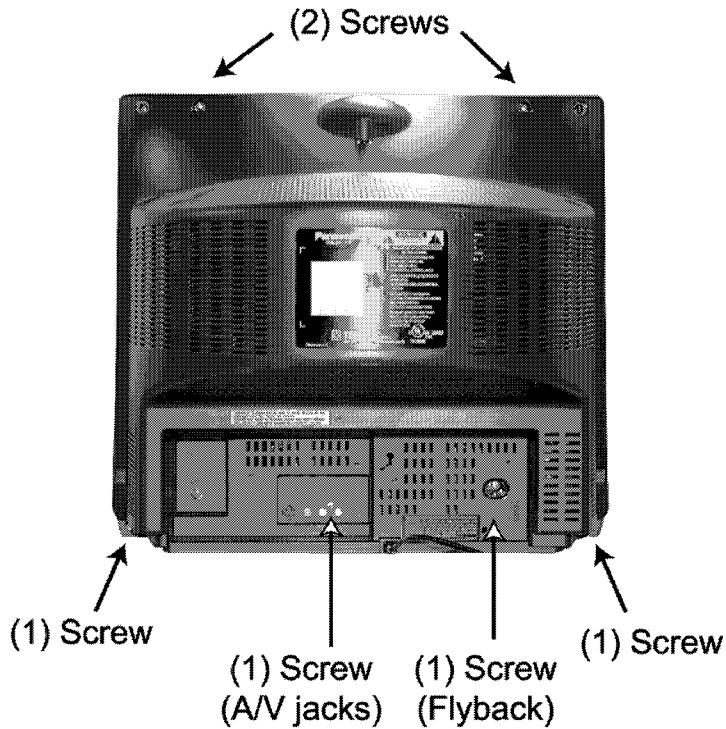

Back Cover Removal (CT-20G8G/CT-20G8SG/CT-20L8G).

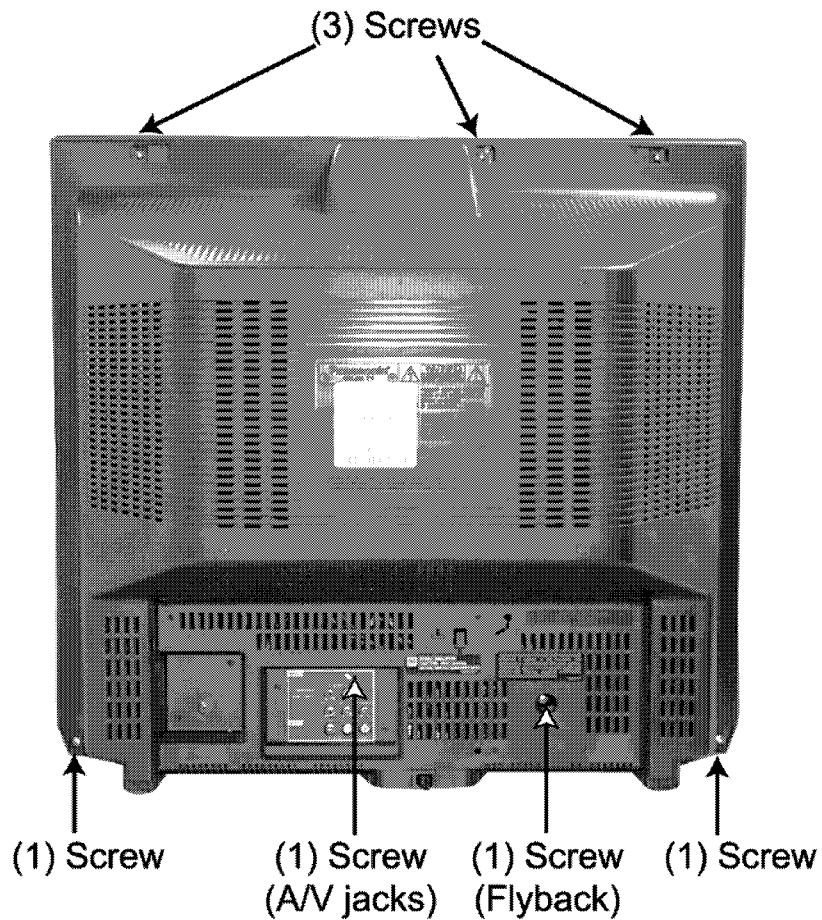

Back Cover Removal (CT-25L8G/CT-25L8UG).

14.2. Chassis Components

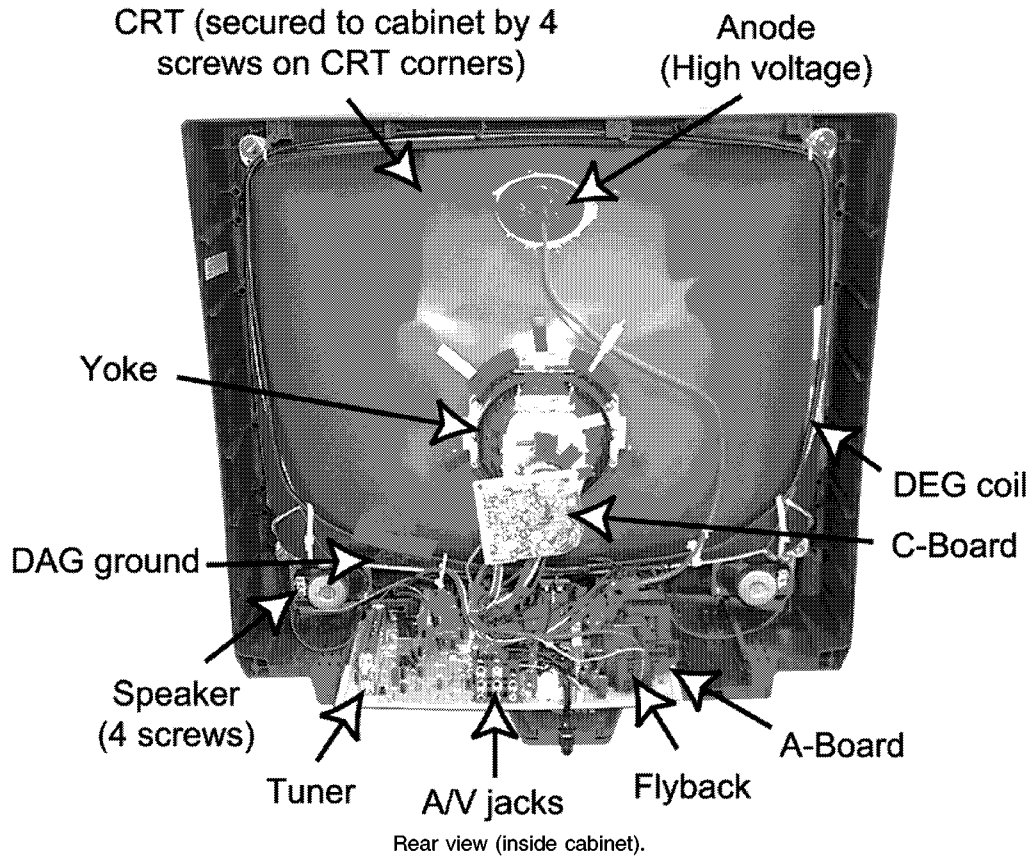

14.2.1. C-Board Chassis

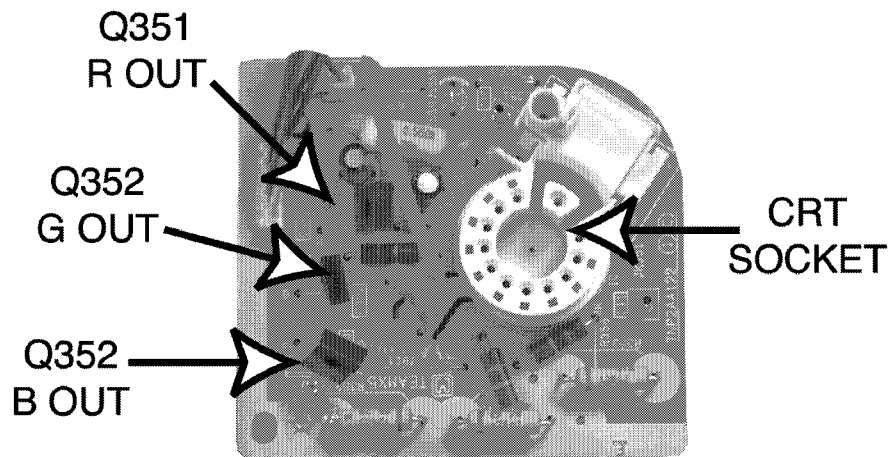

C-Board component locations

14.2.2. CT-20G8G/CT-20G8SG A-Board Chassis

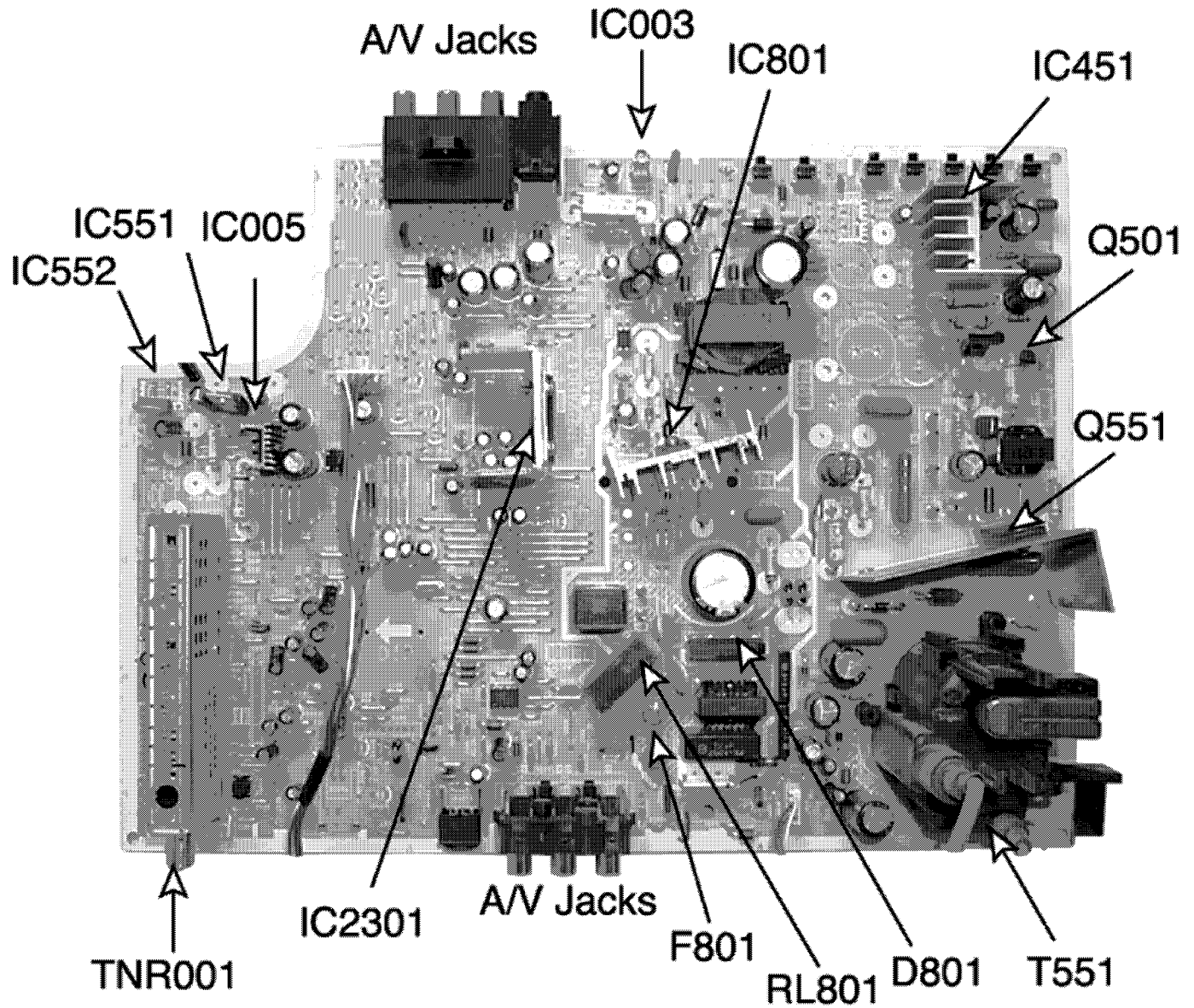

A-Board Top view (CT-20G8G/CT-20G8SG).

14.2.3. CT-20L8 A-Board Chassis

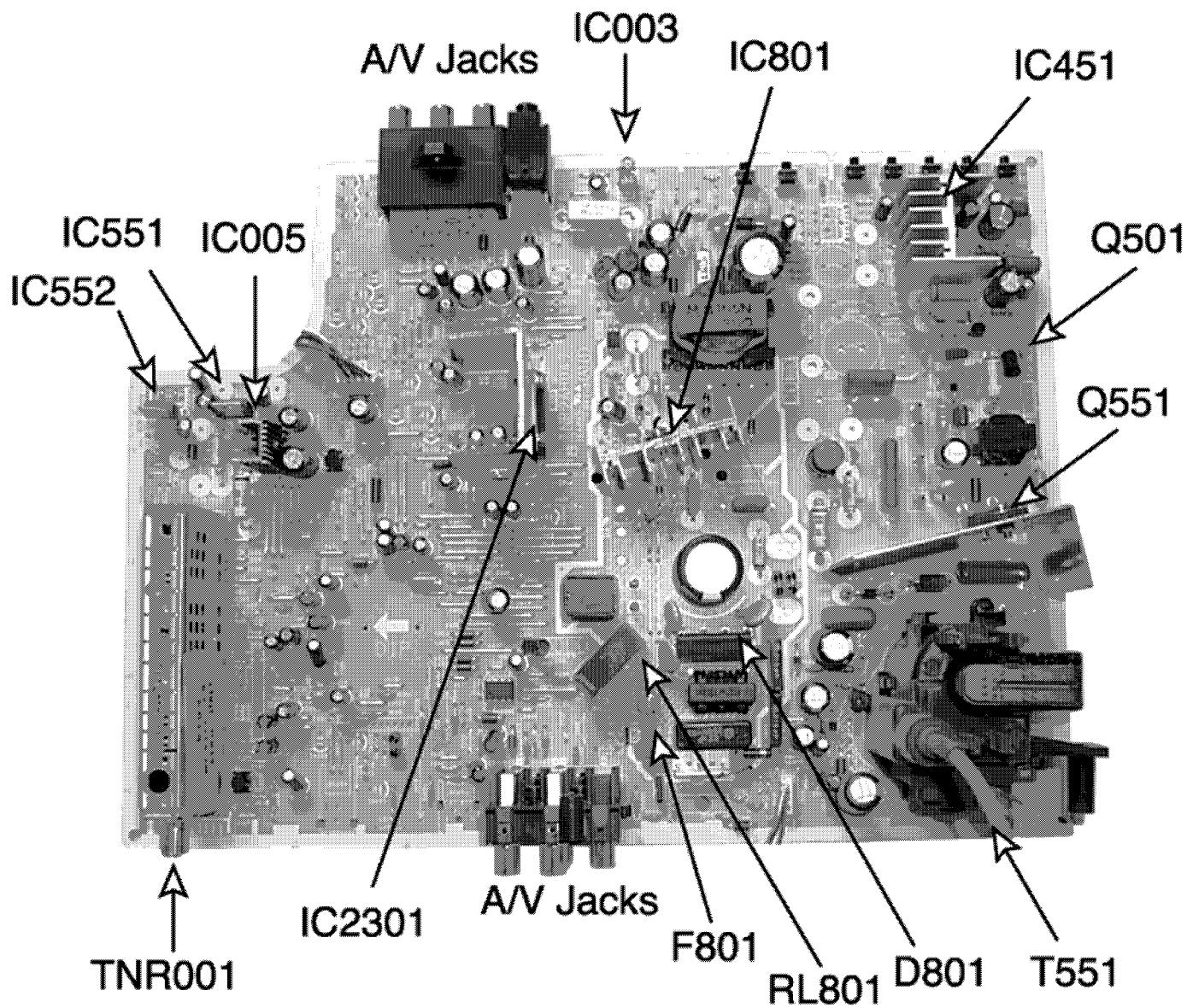

A-Board Top view (CT-20L8G)

14.2.4. CT-25L8/CT-25L8U A-Board Chassis

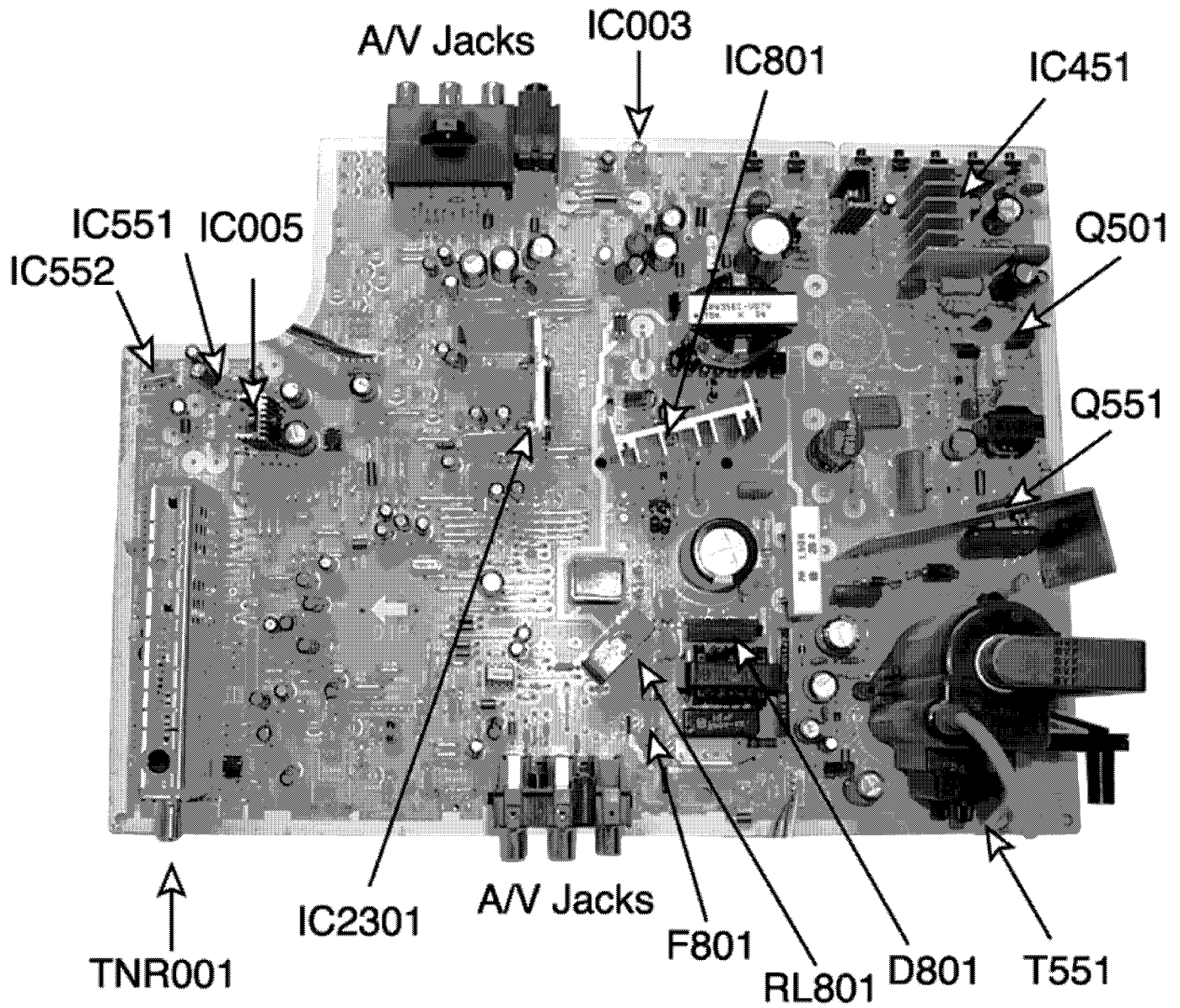

A-Board Top view (CT-25L8G/CT-25L8UG).

14.2.5. A-Board Surface-mounted components

IC2201

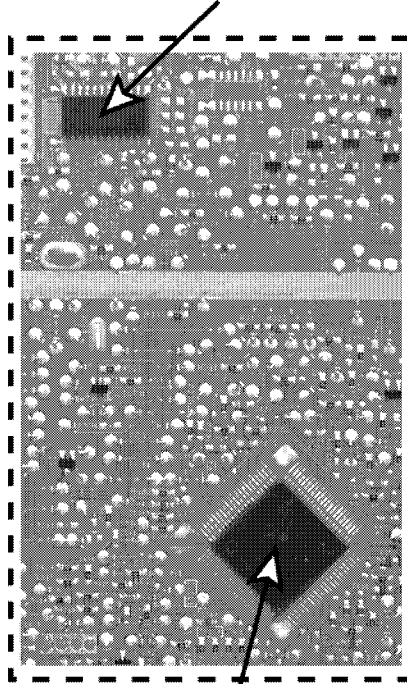

IC001

A-Board (bottom view)

15 Reference for PDF Colors

DESCRIPTION OF PDF LINK COLORS	
TYPE	DESTINATION
SCHEMATIC	
YELLOW ON IC	IC ON PCB
YELLOW ON CONNECTOR	CONNECTOR ON PCB
YELLOW ON SCHEMATIC	PCB
CYAN	WAVEFORM
GREEN ON SIDE	SCHEMATIC CONTINUED
GREEN ON CONNECTOR	CONNECTOR CONNECTION
BLUE ON IC	VOLTAGE
PCB	
BLUE ON IC	IC ON SCHEMATIC
BLUE ON CONNECTOR	CONNECTOR ON SCHEMATIC
BLUE ON PCB	SCHEMATIC
GREEN ON SIDE	PCB CONTINUED
BLOCK DIAGRAMS	
GREEN ON IC	IC ON SCHEMATIC
GREEN ON SIDE	BLOCK DIAGRAM CONTINUED

16 Conductor Views

16.1. A-Board Printed Circuit (Left Side)

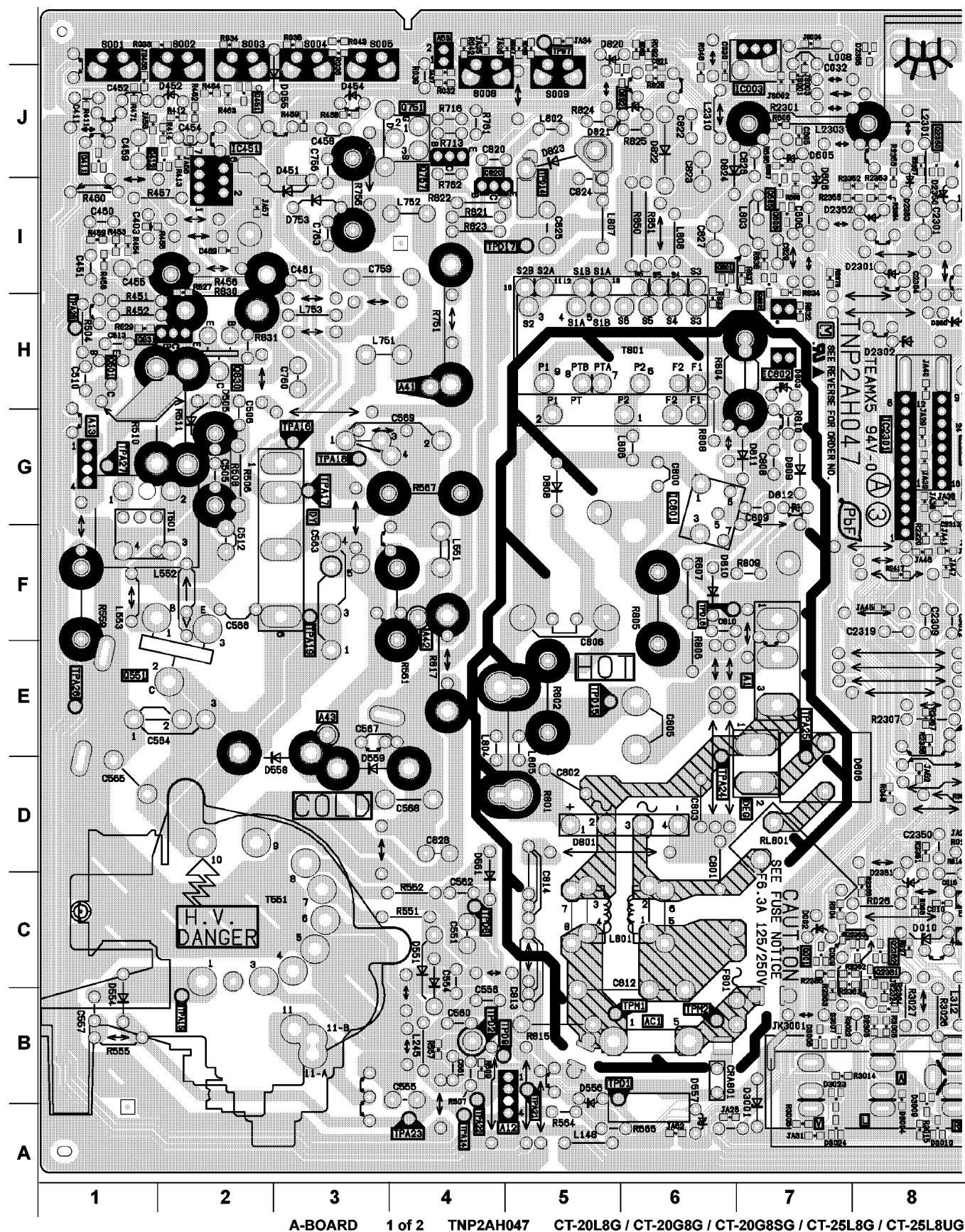

A-BOARD 1 of 2 TNP2AH047 CT-20L8G / CT-20G8G / CT-20G8SG / CT-25L8G / CT-25L8UG

16.2. A-Board & C Board Printed Circuit (Right Side)

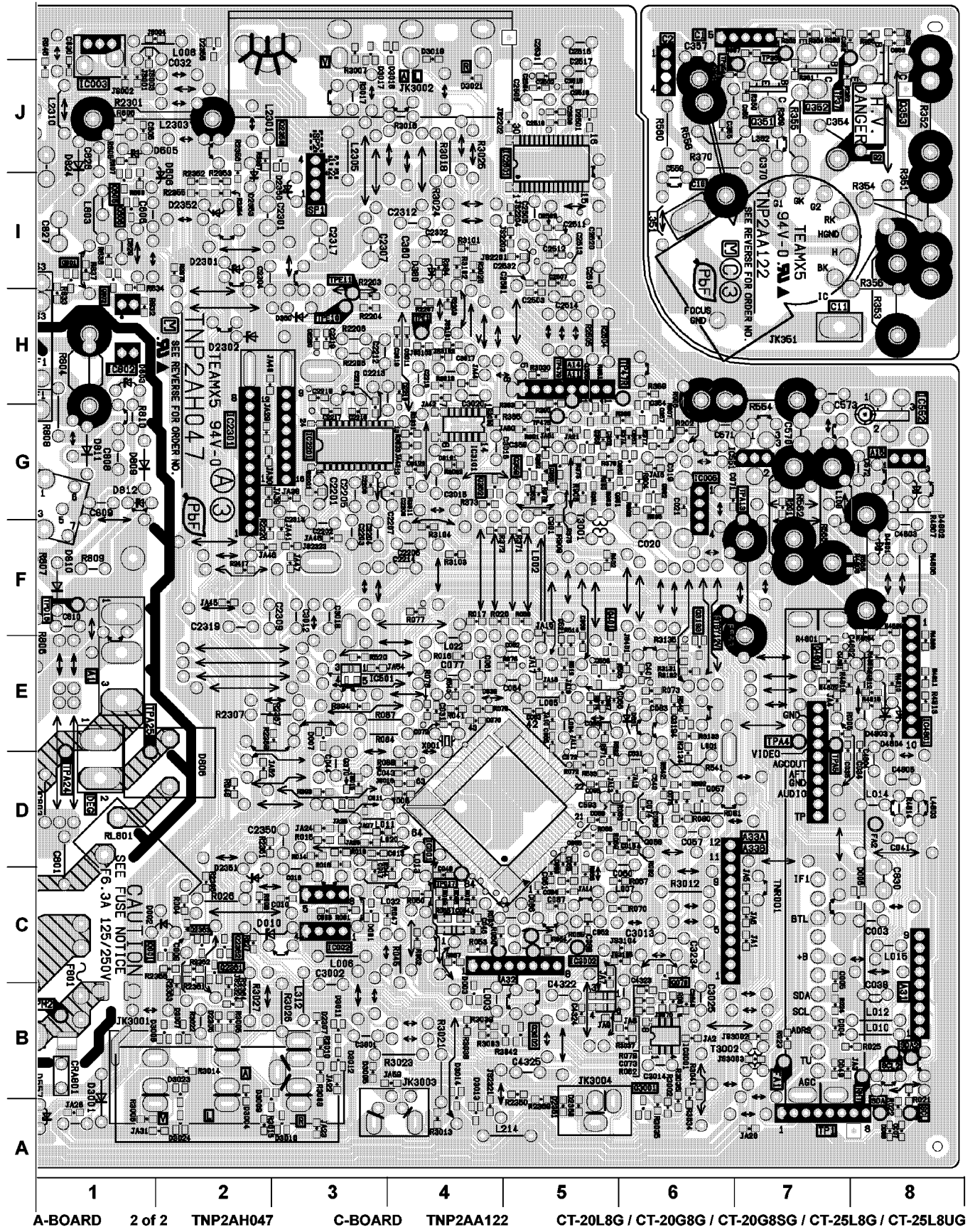

17 Block Diagrams

17.1. Video Signal Block Diagram

Video signal path block diagram

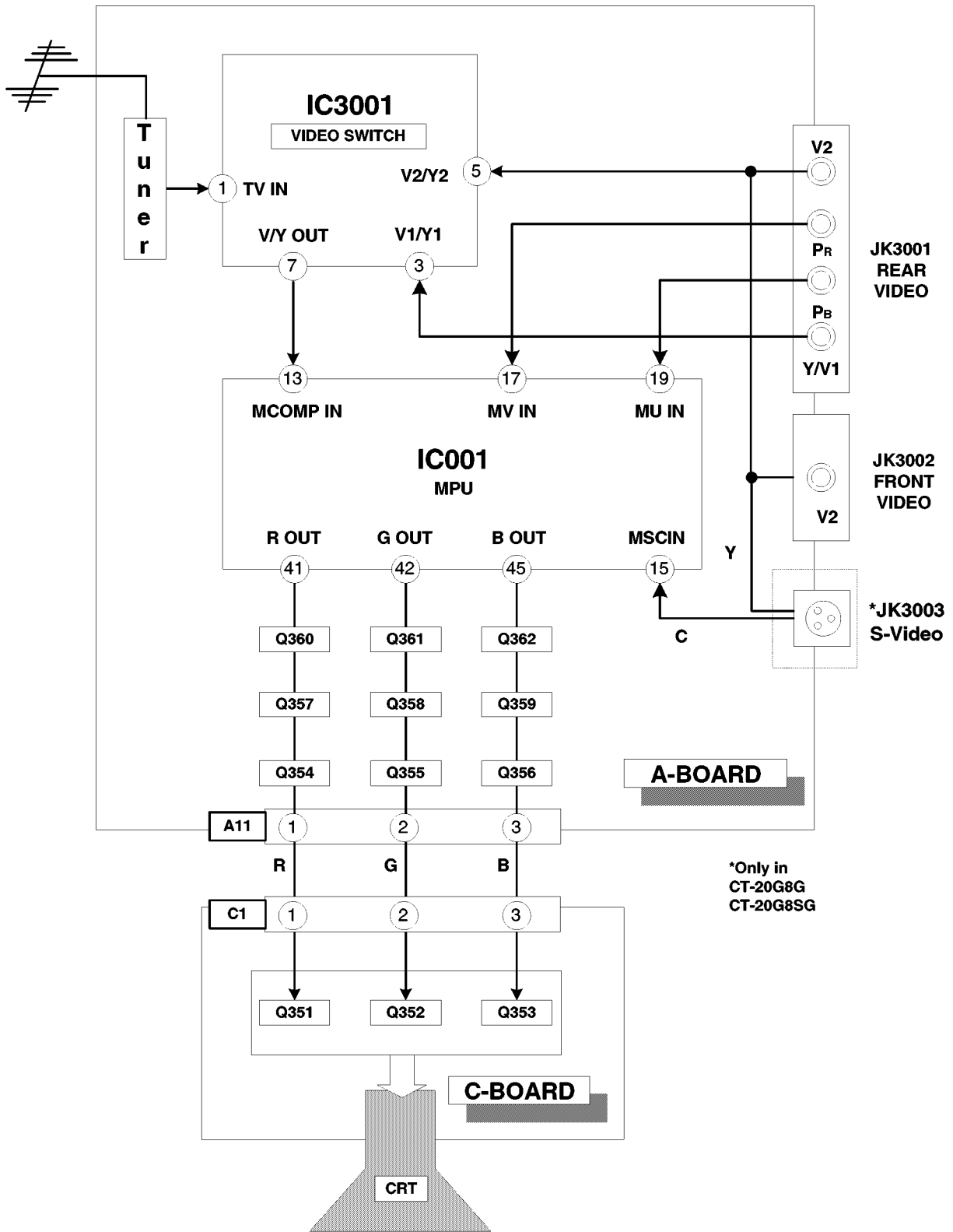

CT-20L8G / CT-20G8G / CT-20G8SG / CT-25L8G / CT-25L8UG

17.2. Audio Signal Block Diagram

Audio signal path block diagram

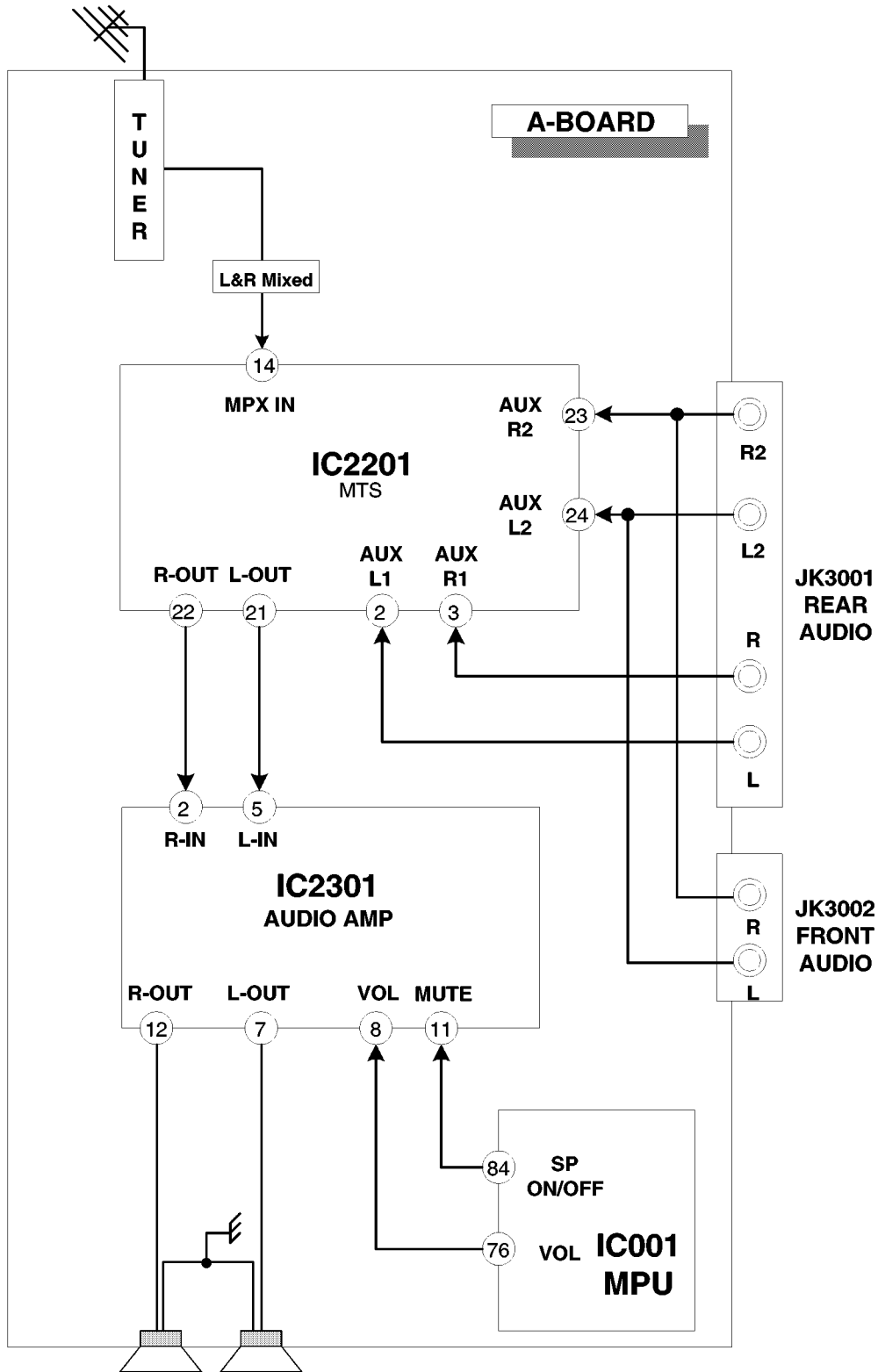

CT-20L8G / CT-20G8G / CT-20G8SG / CT-25L8G / CT-25L8UG

18 Schematics

18.1. English Schematic Notes

Notes:

IMPORTANT SAFETY NOTICE

THIS SCHEMATIC DIAGRAM INCORPORATES SPECIAL FEATURES THAT ARE IMPORTANT FOR PROTECTION FROM X-RADIATION, FIRE AND ELECTRICAL SHOCK HAZARDS. WHEN SERVICING IT IS ESSENTIAL THAT ONLY MANUFACTURERS SPECIFIED PARTS BE USED FOR THE CRITICAL COMPONENTS DESIGNATED WITH A \triangle IN THE SCHEMATIC.

CHIP TRANSISTOR LEAD DESIGNATION

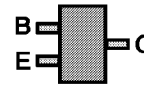

SCHEMATIC NOTES

- Resistors are carbon 1/4W unless noted otherwise.
 - Capacitors are ceramic 50V unless noted otherwise.
 - Coil value notes is inductance in μH .
 - Test point indicated by \uparrow ; Test point but no pin \uparrow .
 - Components indicated with \triangle are critical parts and replacement should be made with manufacture specified replacement parts only.
 - (BOLD LINE) indicates the route of B+ supply.
 - The schematic diagrams are current at the time of printing and are subject to change without notice.
 - Ground symbol \downarrow indicates **HOT GROUND CONNECTION**; \uparrow indicates COLD GROUND.
- NOTE: All other component symbols are used for engineering design purposes.*

VOLTAGE MEASUREMENTS

- Voltage measurement:
 - AC input to the Receiver is 120V. NTSC (HD, 1125i & 525P when applicable) signal generator is connected to the antenna of the Receiver. (Color bar pattern of 100 IRE white and 7.5 IRE black.)
 - All Picture and Audio adjustments are set to Normalize.
TV ANT/CABLE - (Set-Up Menu) in TV/ANT Mode
Volume - Min.
TV/Video SW - TV position
Audio Mode - Stereo
 - Voltage readings are nominal and may vary $\pm 10\%$ on active devices. Some voltage reading will vary with signal strength and picture content.
 - Supply voltages are nominal.
 - Ground symbol \downarrow indicates ground lead connection of meter. Incorrect ground connection will result in erroneous readings.
- CAUTION: Incorrect ground connection of the test equipment will result in erroneous readings.*

WAVEFORM MEASUREMENTS

- $\textcircled{3}$ indicates waveform measurement. (Measurement can be taken at the best accessible location in common to the indicated point.)
 - Taken with an NTSC signal generator connected to the antenna terminal. (NTSC color bar pattern of 8 bars of EIA colors, 100 IRE white and 7.5 IRE black.)
 - Customer Controls (Picture/Audio Menu) are set to Normalize. Volume is set to "MIN".
 - All video and color waveforms are taken with a wideband scope and a probe with low capacitance (10 to 1). Shape and peak altitudes may vary depending on the type of Oscilloscope used and its settings.
 - Ground symbol \downarrow shown on waveform number indicates (Hot) ground lead connection of the Oscilloscope.
- CAUTION: Incorrect ground connection of the test equipment will result in erroneous readings.*

18.2. Notas de Esquemáticos en Español

Notas

NOTA DE SEGURIDAD

LOS DIAGRAMAS ELÉCTRICOS INCLUYEN CARACTERÍSTICAS ESPECIALES MUY IMPORTANTES PARA LA PROTECCIÓN CONTRA RAYOS-X, QUEMADURAS Y DESCARGAS ELÉCTRICAS. CUANDO SE DE SERVICIO ES IMPORTANTE USAR PARA REEMPLAZO DE COMPONENTES CRÍTICOS, SOLO PARTES ESPECIFICADAS POR EL FABRICANTES. LOS COMPONENTES CRÍTICOS ESTAN SEÑALADOS EN LOS DIAGRAMAS POR EL SIMBOLO \triangle .

IDENTIFICACIÓN DE TERMINALES PARA TRANSISTORES EN CHIP

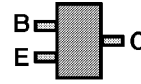

NOTAS DE LOS DIAGRAMAS

- Las Resistencias son de Carbón de 1/4W, a menos que se indique otra característica.
 - Los Capacitores son de Cerámica para 50V, a menos que se indique otra característica.
 - El valor indicado de las Bobinas es la inductancia expresada en μH .
 - Los puntos de prueba en la terminal de algún componente son indicados por \uparrow . Los puntos de prueba fuera de los componentes se indican con \uparrow .
 - Los componentes señalados con el símbolo \triangle son considerados componentes críticos y deben ser reemplazados sólo con las partes especificadas por el fabricante.
 - (LINEA GRUESA)** indica las líneas de alimentación de los Voltajes B+.
 - Los diagramas eléctricos están sujetos a cambio sin previo aviso.
 - El símbolo \downarrow indica que es una conexión a **Tierra Caliente** y el símbolo \uparrow indica conexión a **Tierra Fría**.
- NOTA:** Los demás símbolos de componentes incluidos son usados con fines de diseño.

MEDICIÓN DE VOLTAJES

- Medición de voltaje:
 - El voltaje de entrada al Receptor es de 120V de Corriente Alterna. Un generador de patrones con formato NTSC se conecta a la entrada de la antena. (Patrón de Barras de Colores con 100 IREs para el Blanco y 7.5 IREs para el Negro.)
 - Los ajustes de los Menus Picture y Audio se normalizan. En el Menú Set-Up, en la opción ANTENA, se selecciona el modo de CABLE. El nivel de Volumen se minimiza. De los modos TV y Video, seleccionar el modo TV. Seleccionar modo Estereo del Audio.
 - Las mediciones de los voltajes son nominales y pueden variar hasta 10% en componentes en funcionamiento. Las lecturas de los voltajes pueden variar por la potencia de la señal y el contenido de la imagen.
 - Las fuentes de voltajes son nominales.
 - El símbolo \downarrow indica el tipo de tierra que se utiliza en la conexión del medidor.
- PRECAUCION:** Si no se utiliza la conexión a la tierra adecuada, se obtendrán mediciones equivocadas y podría dañar el equipo de medición.

MEDICIÓN DE FORMAS DE ONDA

- Un símbolo como $\textcircled{3}$ indica el punto para medir una señal. (La medición puede hacerse en el punto con mayor accesibilidad, siempre que sea común al indicado.)
 - Se midieron utilizando un generador con formato NTSC conectado a la terminal de la antena. (Patrón de 8 Barras de Colores EAI, formato NTSC de 100 IREs para el Blanco y 7.5 IREs para el Negro.)
 - Los ajustes de usuario de los Menus PICTURE y AUDIO se normalizaron. Posteriormente el nivel de volumen se ajusta al mínimo.
 - Las formas de onda de Video y Color fueron tomadas con un osciloscopio de banda alta y con un punta de prueba de baja capacitancia (10 a 1). La forma y amplitud de las ondas puede variar según el tipo de osciloscopio que se utilice y sus características.
 - El símbolo de tierra \downarrow que aparece junto al número de la forma de onda, indica que se utiliza conexión a **Tierra Caliente** en el extremo negativo de la punta de prueba.
- PRECAUCION:** Si no se utiliza la conexión a la tierra adecuada, se obtendrán mediciones equivocadas y podría dañar el equipo de medición.

18.3. A-Board Schematic TNP2AH047AA/AB (page 1 of 4)

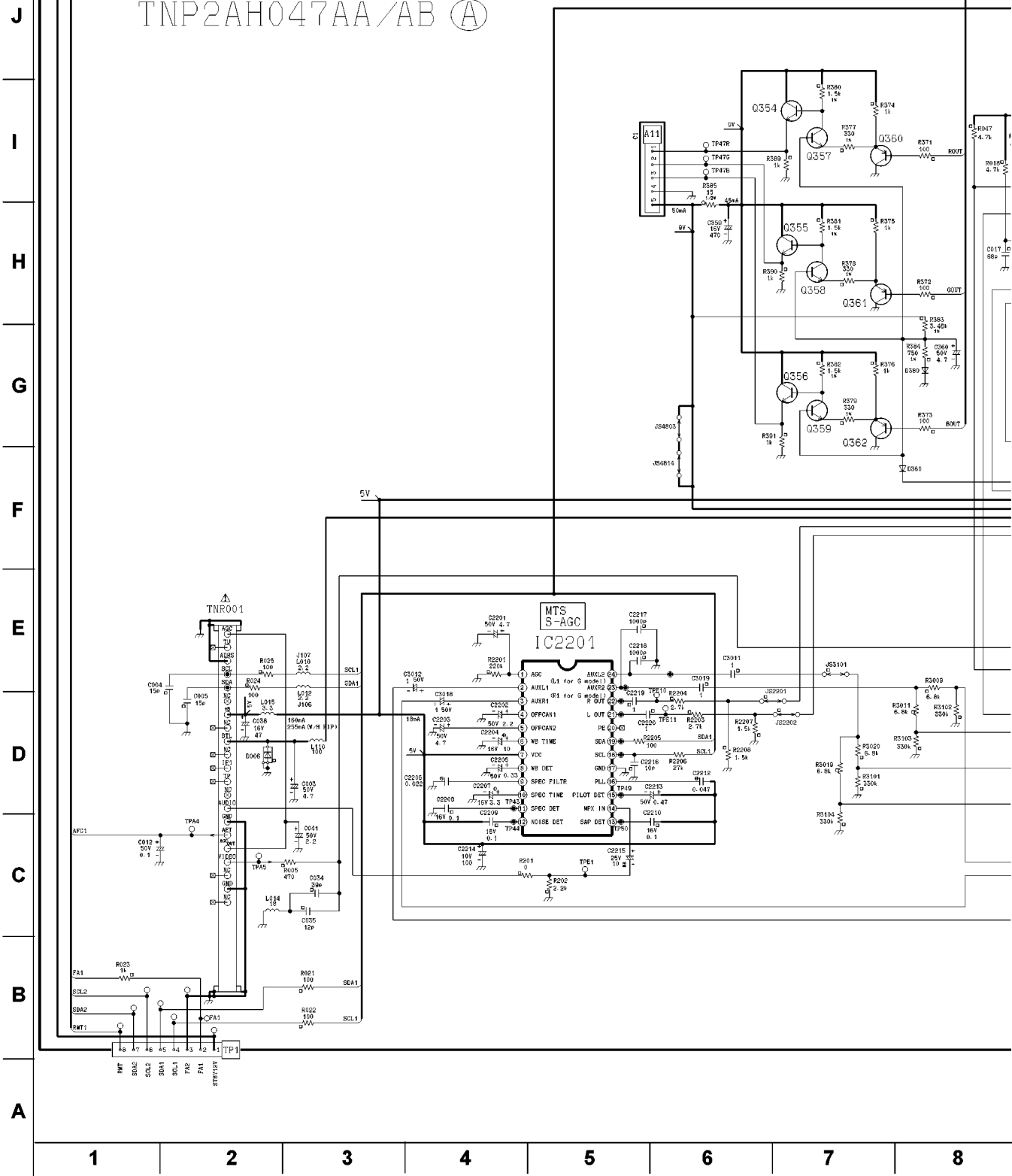

18.4. A-Board Schematic TNP2AH047AA/AB (page 2 of 4)

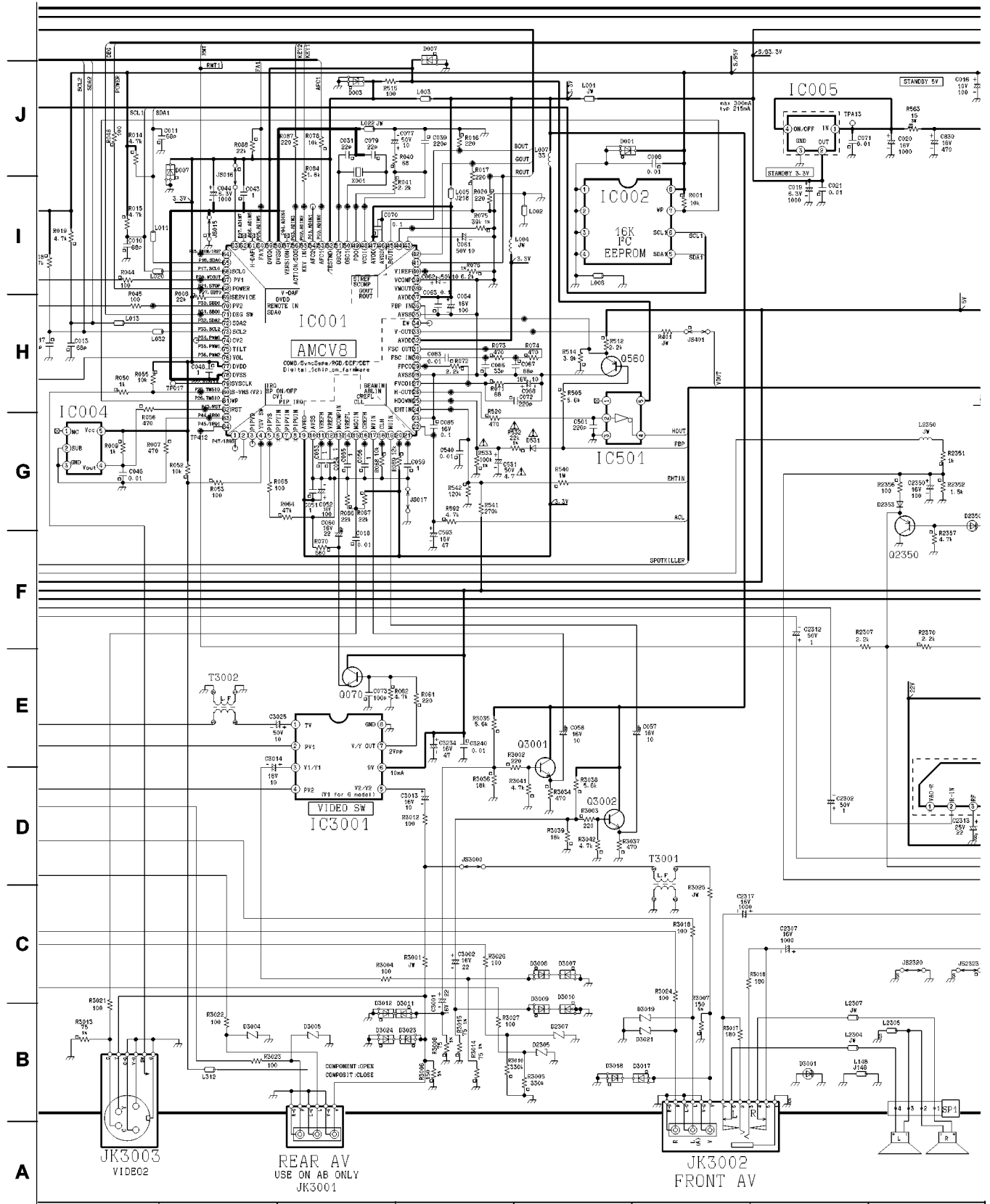

1
2
3
4
5
6
7
8

A-BOARD
2 of 4
TNP2AH047AA/AB
CT-20L8 / CT-20G8 / CT-20G8S

18.5. A-Board Schematic TNP2AH047AA/AB (page 3 of 4)

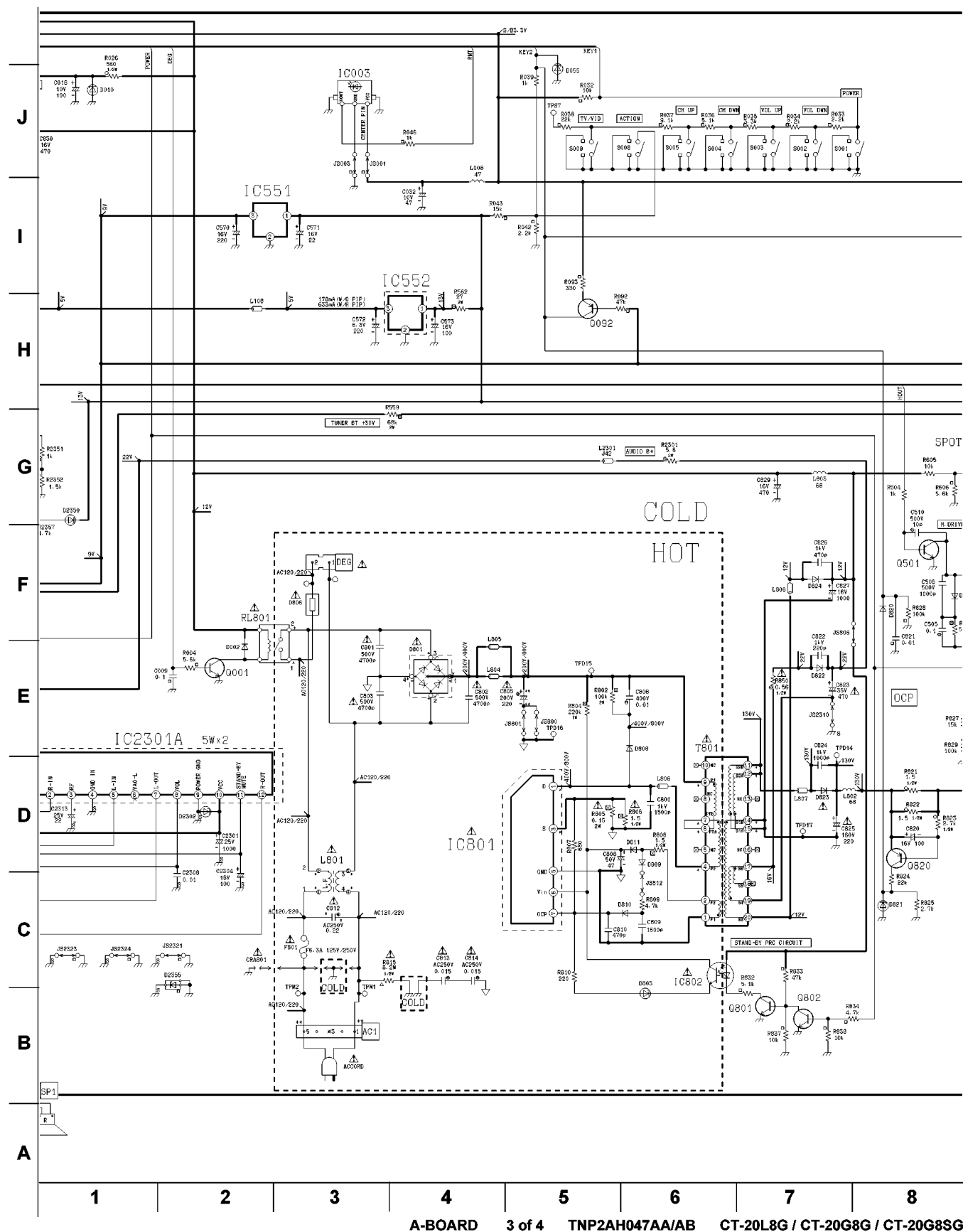

A-BOARD 3 of 4 TNP2AH047AA/AB CT-20L8G / CT-20G8G / CT-20G8SG

18.6. A-Board Schematic TNP2AH047AA/AB (page 4 of 4)

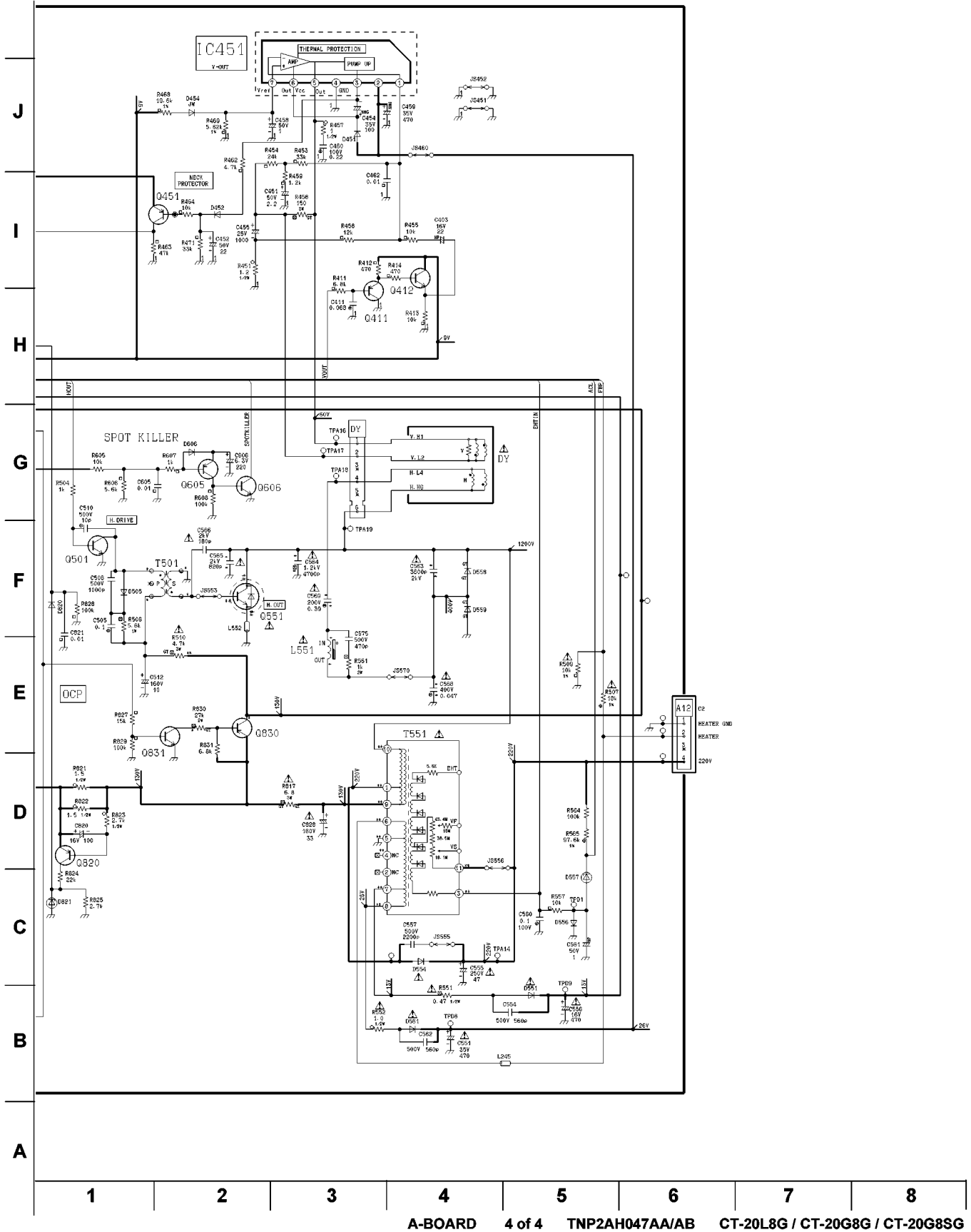

18.7. A-Board Schematic TNP2AH047FA (page 1 of 4)

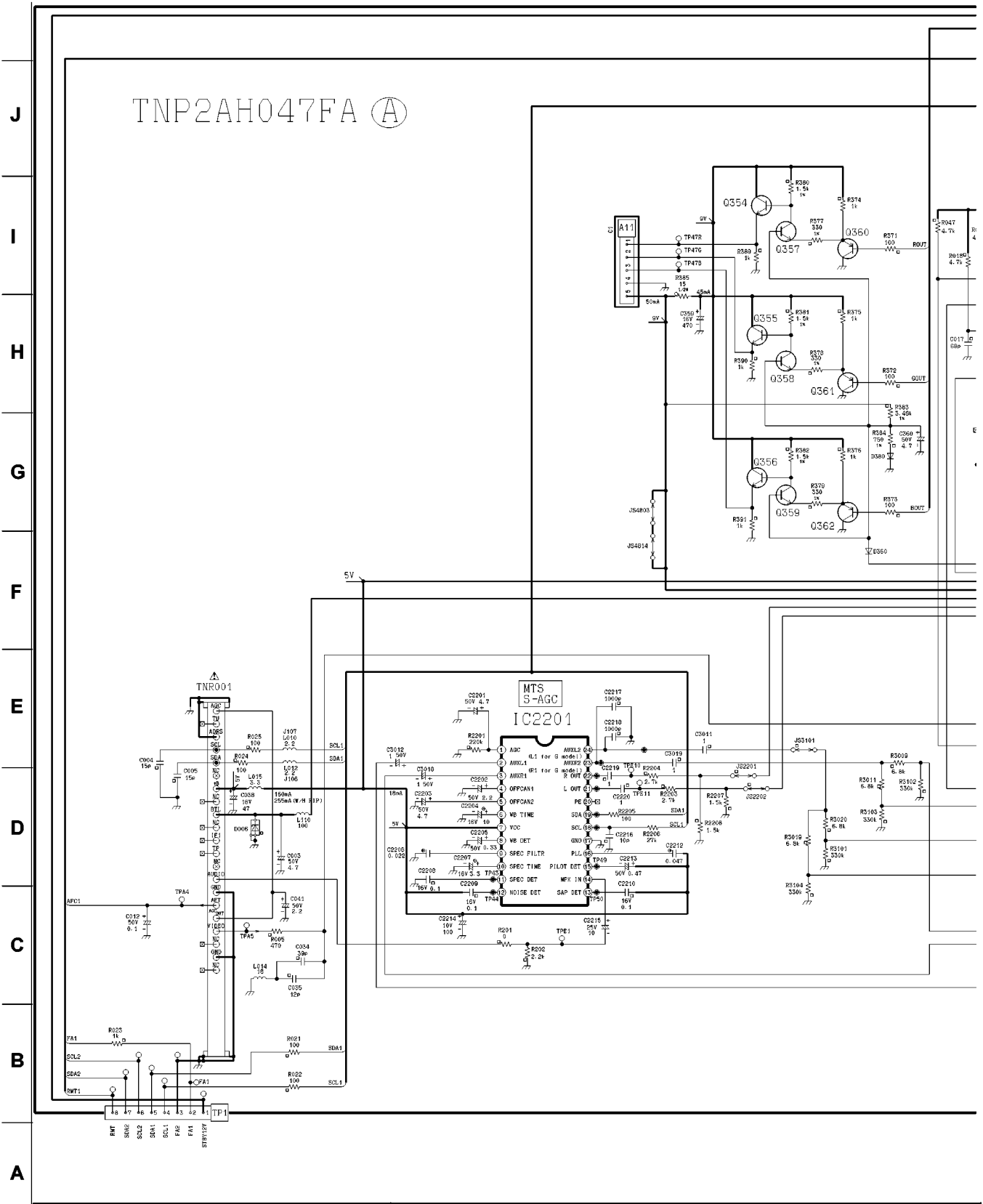

1	2	3	4	5	6	7	8
---	---	---	---	---	---	---	---

A-BOARD 1 of 4 TNP2AH047FA CT-25L8G / CT-25L8UG

18.8. A-Board Schematic TNP2AH047FA(page 2 of 4)

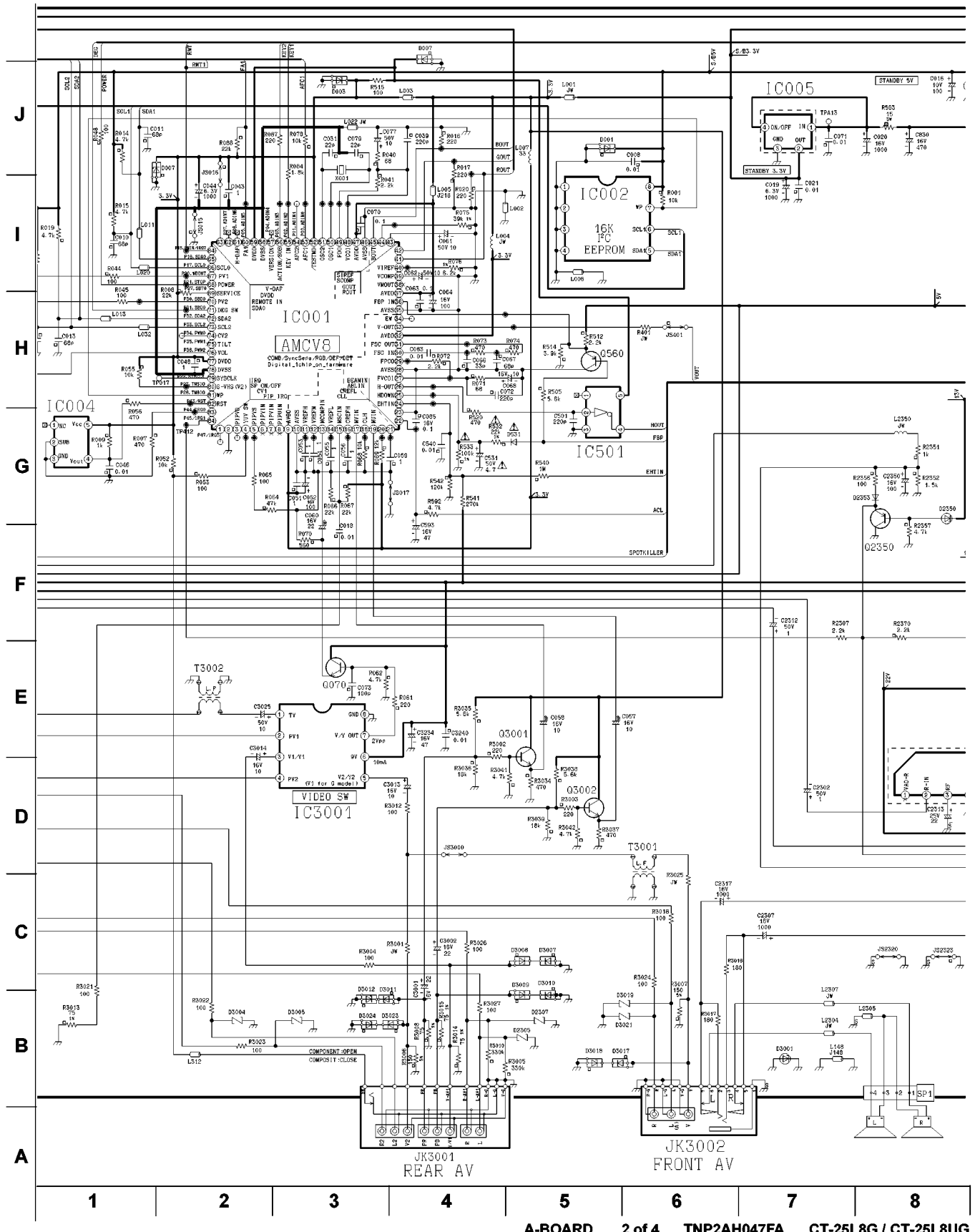

A-BOARD 2 of 4 TNP2AH047FA CT-25L8G / CT-25L8UG

18.9. A-Board Schematic TNP2AH047FA (page 3 of 4)

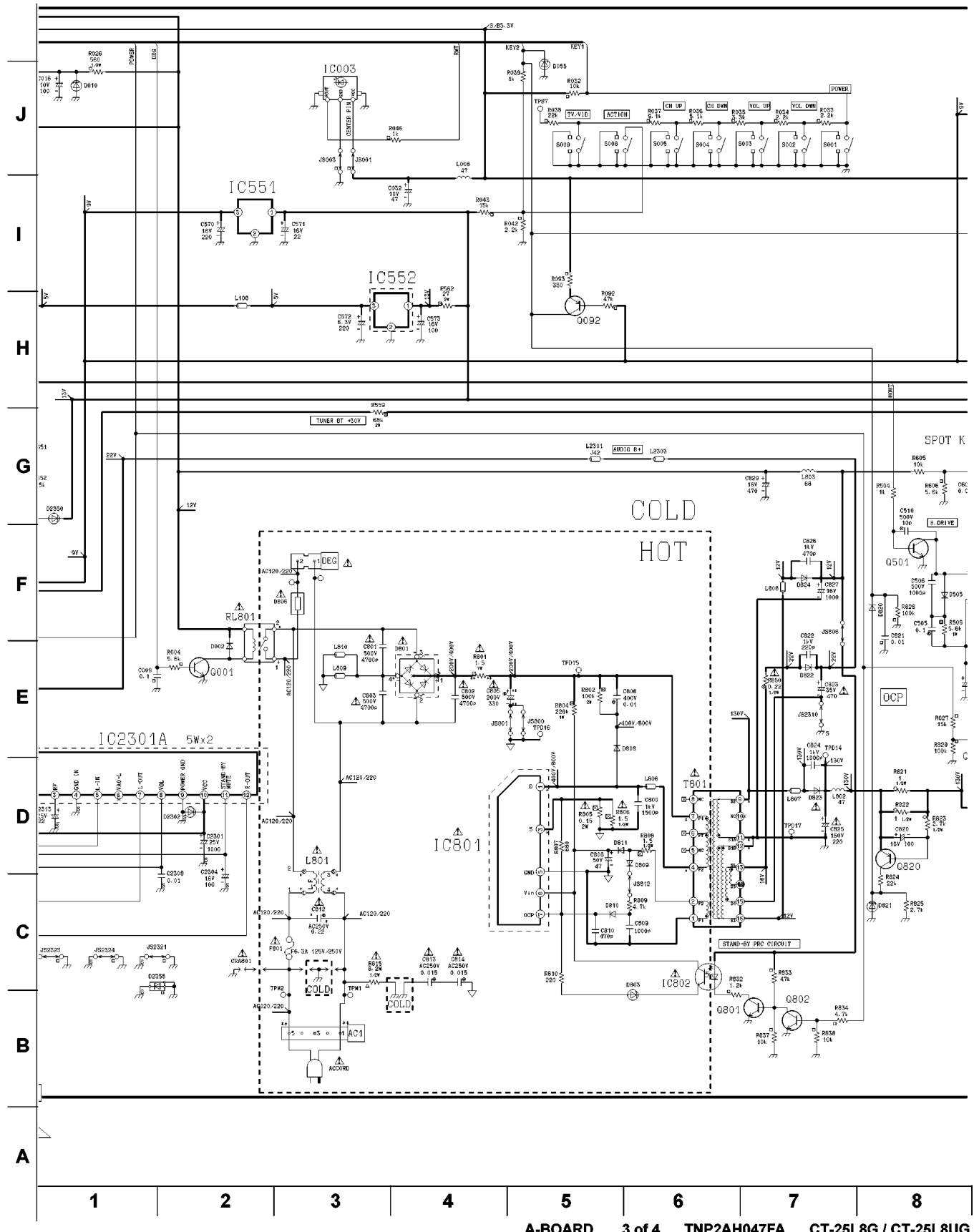

18.10. A-Board Schematic TNP2AH047FA (page 4 of 4)

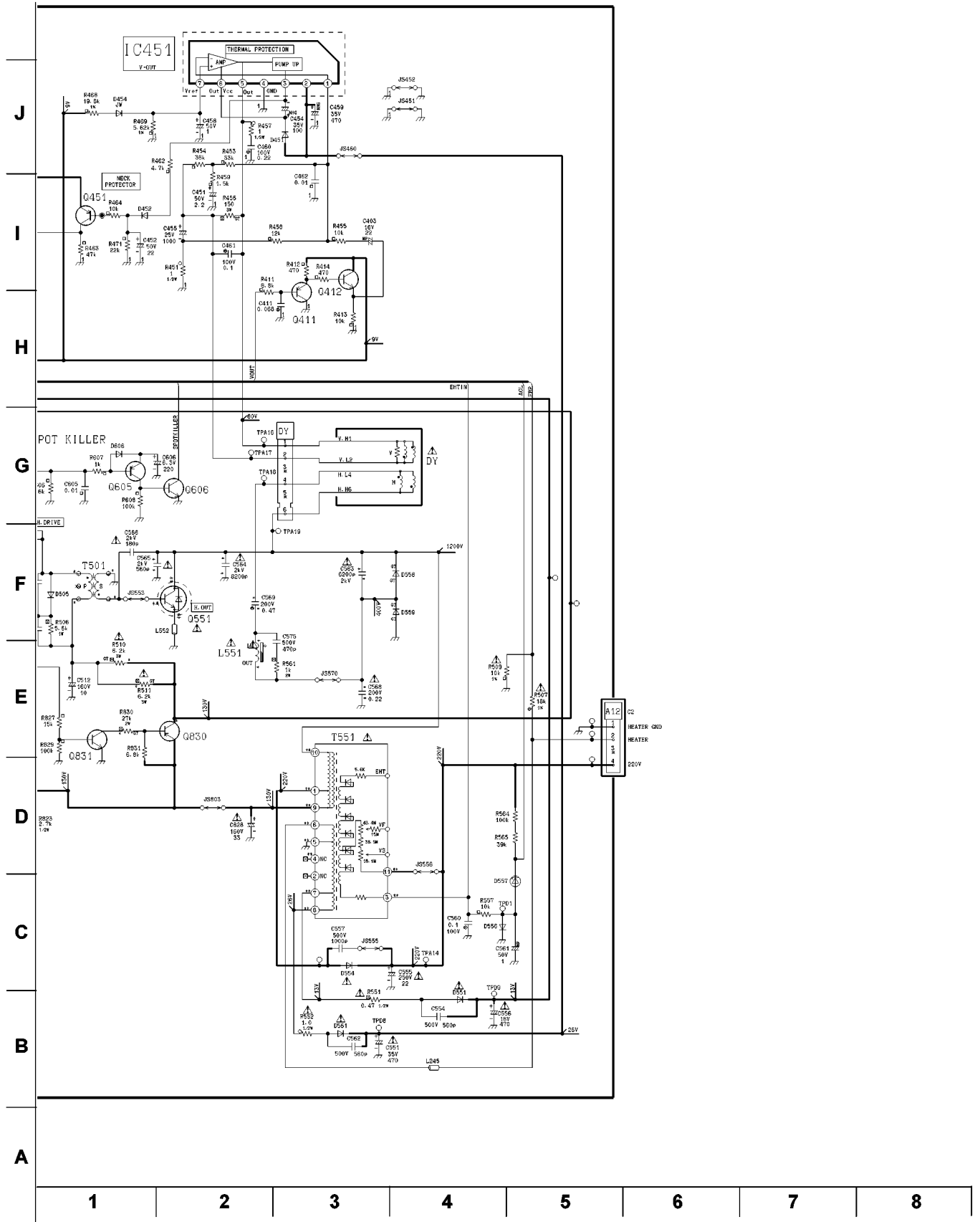

18.11. C-Board Schematic TNP2AA122AA/FA

J
I
H
G
F
E
D
C
B
A

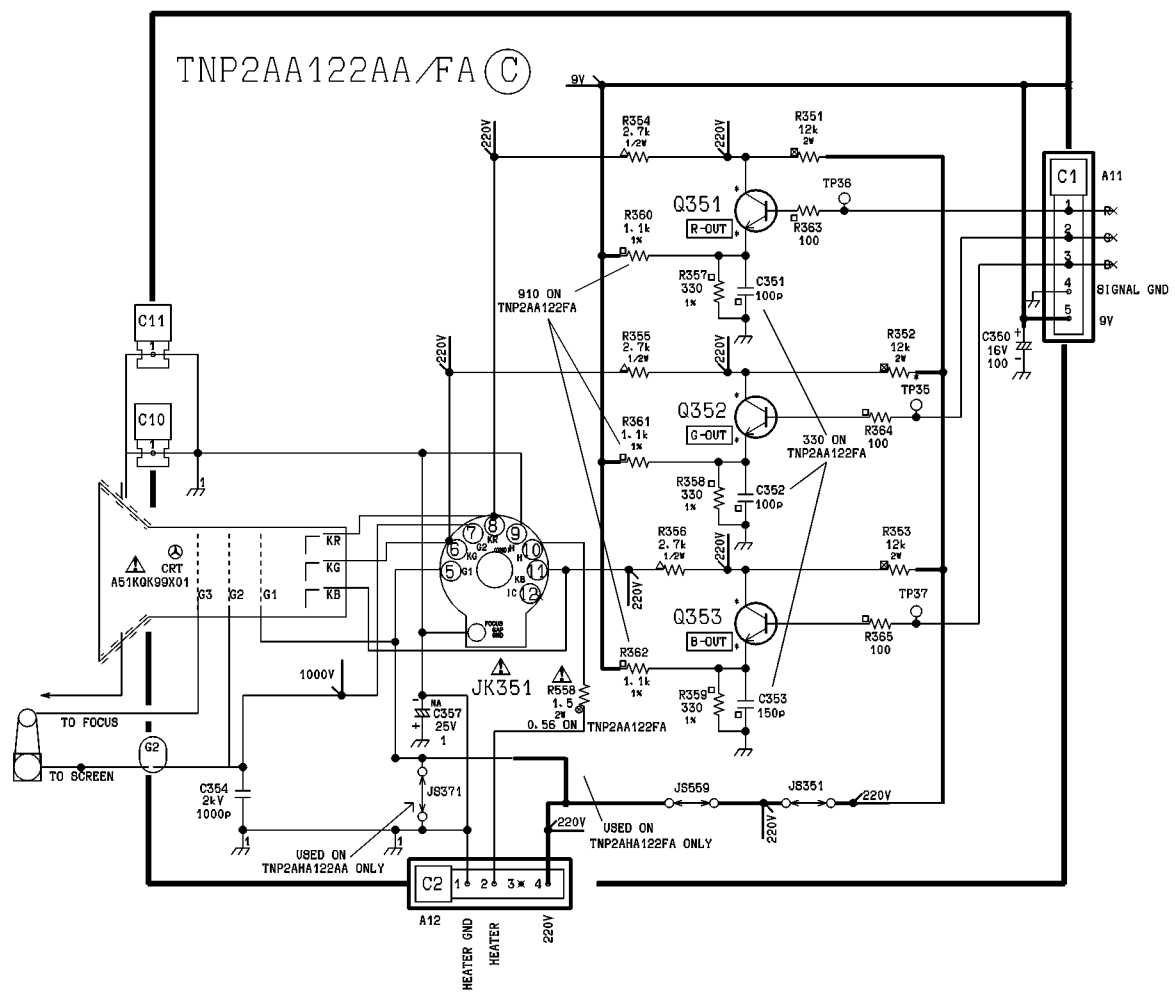

1	2	3	4	5	6	7	8
C-BOARD			TNP2AA122FA/AA	CT-20L8G / CT-20G8G / CT-20G8SG / CT-25L8G / CT-25L8UG			

18.12. Voltages

A - BOARD																			
IC001				IC002				IC501				IC2201							
1	0.00	43	2.50	1	0.00	1	0.00	1	1.60	13	2.80		
2	0.00	44	1.70	2	0.00	2	1.35	2	2.20	14	2.20		
3	0.00	45	0.00	3	0.00	3	0.00	3	2.20	15	2.50		
4	0.00	46	0.00	4	0.00	4	1.05	4	2.30	16	3.50		
5	0.00	47	3.30	5	3.40	5	3.30	5	2.40	17	0.00		
6	1.20	48	1.90	6	3.40	IC551				6	0.07	18	3.20	
7	1.20	49	1.90	7	5.20	1	12.20	7	5.00	19	3.40		
8	1.30	50	1.60	8	5.20	2	0.00	8	2.50	20	0.00		
9	3.30	51	1.70	IC003				3	9.00	9	2.60	21	2.20	
10	0.00	52	3.30	1	0.00	IC552				10	0.80	22	2.20	
11	2.70	53	1.70	2	3.31	1	7.50	11	2.30	23	2.20		
12	1.50	54	1.40	3	3.27	2	0.00	12	2.50	24	2.20		
13	1.40	55	3.30	IC004				3	5.00	IC2301						
14	0.40	56	1.40	1	0.00	IC801 ↓				1	6.40	IC3001			
15	1.60	57	0.00	2	0.00	1	-21.00	2	5.60	1	4.10		
16	2.20	58	0.00	3	0.00	2	N/A	3	16.80	2	0.20		
17	0.07	59	3.30	4	3.30	3	0.10	4	0.00	3	4.10		
18	1.70	60	3.30	5	3.30	4	N/A	5	5.60	4	0.00		
19	0.00	61	3.30	IC005				5	0.00	6	6.30	5	4.10	
20	1.40	62	0.70	1	9.10	6	32.24	7	8.60	6	9.00		
21	1.00	63	3.30	2	3.30	7	1.50	8	0.00	7	4.30		
22	2.60	64	3.30	3	0.00	IC802 ↓				8	0.00				
23	0.00	65	3.40	4	9.10	1	2.30	9	0.00					
24	1.90	66	3.50	IC451				2	32.24	10	18.30				
25	1.90	67	0.10	1	2.00					11	3.10				
26	1.40	68	3.20	2	23.30					12	8.70				
27	0.00	69	0.00	3	1.20											
28	0.00	70	0.00	4	0.00											
29	1.30	71	0.00	5	11.60											
30	1.80	72	5.20	6	23.50											
31	1.00	73	5.20	7	2.00											
32	3.30	74	0.00														
33	1.70	75	0.00														
34	0.80	76	0.00														
35	0.00	77	3.30														
36	0.60	78	0.00														
37	3.30	79	0.00														
38	3.30	80	3.30														
39	2.30	81	5.20														
40	1.70	82	3.30														
41	0.40	83	0.00														
42	0.40	84	3.30														

CT-20L8G / CT-20G8G / CT-20G8SG / CT-25L8G / CT-25L8UG

A - BOARD

	Q001	Q057	Q058	Q070	Q092	Q2350	Q3001	Q3002	Q354
B	0.00	1.50	1.50	4.12	8.90	5.35	1.30	1.30	4.50
C	13.00	0.00	0.00	8.90	1.40	0.00	3.30	3.30	8.50
E	0.00	0.07	0.07	3.50	3.30	3.14	0.70	0.70	3.80

	Q355	Q356	Q357	Q358	Q359	Q360	Q361	Q362	Q411
B	4.30	4.40	2.60	2.60	2.60	0.50	0.40	0.40	2.25
C	8.40	8.40	4.50	4.30	4.40	0.00	0.00	0.00	0.00
E	3.60	3.70	2.00	2.00	2.00	1.10	1.10	1.10	2.90

	Q412	Q451	Q501	Q551	Q560	Q605	Q606	Q801	Q802
B	2.90	5.10	0.40	0.00	0.30	4.80	0.00	0.00	0.70
C	9.00	1.40	56.80	14.70	0.00	0.00	3.30	12.52	0.00
E	2.40	3.30	0.00	0.00	0.60	4.70	0.00	0.00	0.00

	Q820	Q830	Q831
B	130.40	129.80	0.60
C	0.00	130.40	0.20
E	130.80	130.50	0.00

C - BOARD

	Q351	Q352	Q353
B	130.40	129.80	0.60
C	0.00	130.40	0.20
E	130.80	130.50	0.00

CT-20L8G / CT-20G8G / CT-20G8SG / CT-25L8G / CT-25L8UG

18.13. Waveforms

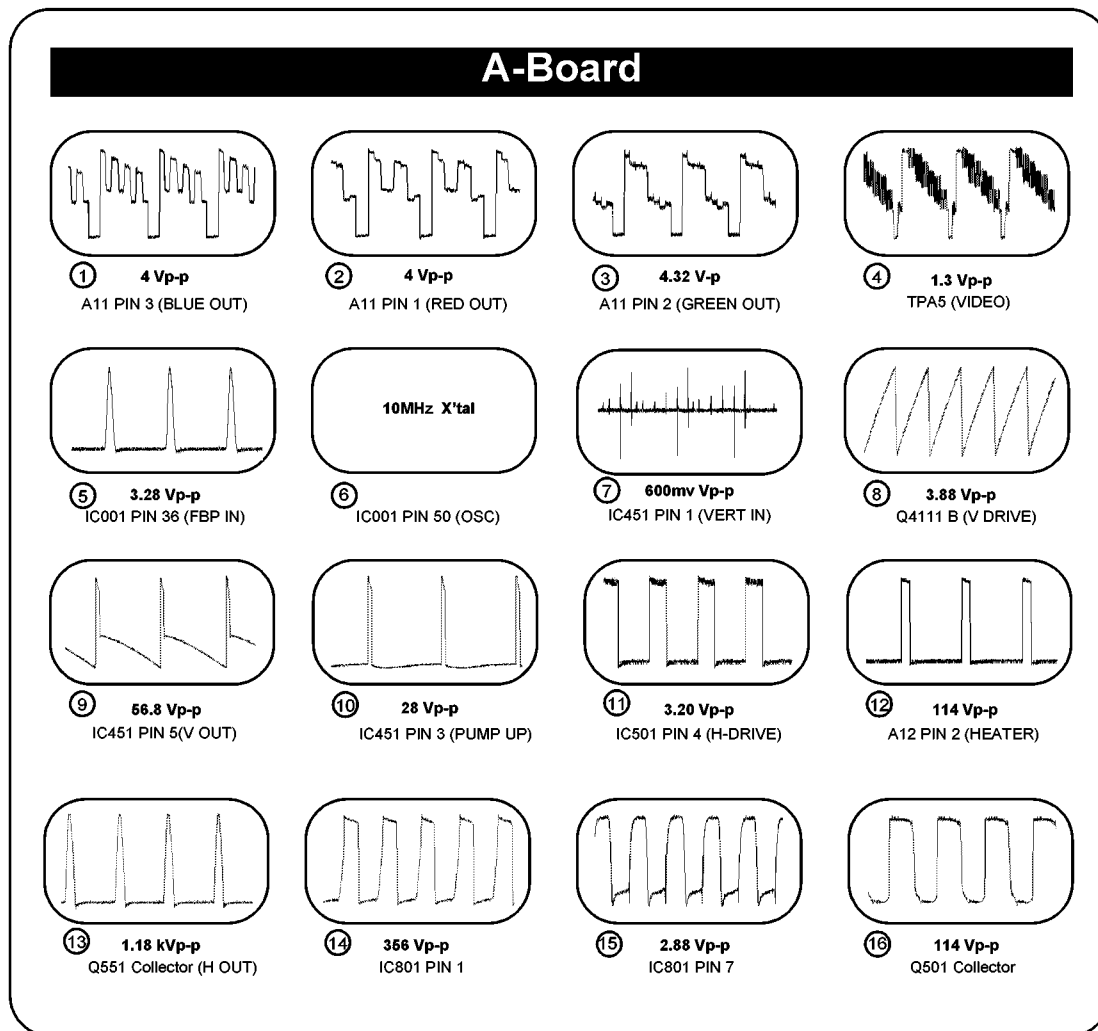

CT-20L8G / CT-20G8G / CT-20G8SG / CT-25L8G / CT-25L8UG

19 Parts Location

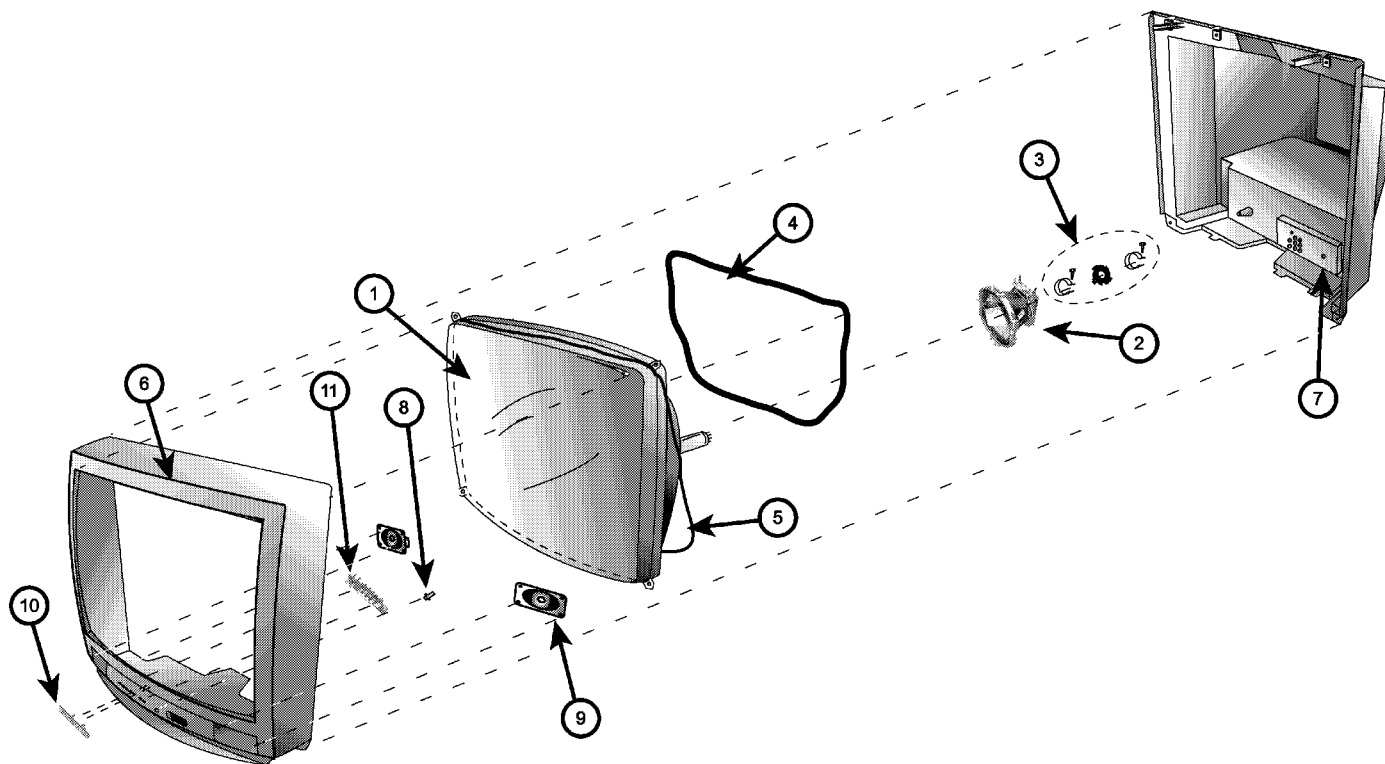

20 Parts List

20.1. Parts List Notes

Important Safety Notice

Components identified by  mark have special characteristics important for safety.
When replacing any of these components, use manufacturer's specified parts.

Abbreviation of part name and description

1. Resistor

Example :

ERD25TJ104 **C** 100K Ω , **J**, 1/4W
Type Allowance

2. Capacitor

Example :

ECKF1H103ZF **C** 0.01 μ F, **Z**, 50V
Type Allowance

Type	Allowance
C : Carbon	F : $\pm 1\%$
F : Fuse	G : $\pm 2\%$
M : Metal Oxide Metal Film	J : $\pm 5\%$ K : $\pm 10\%$
S : Solid	M : $\pm 20\%$
W : Wire Wound	

Type	Allowance
C : Carbon	C : $\pm 0.25\text{pF}$
E : Electrolytic	D : $\pm 0.5\text{pF}$
P : Polyester Polypropylene	F : $\pm 1\text{pF}$ G : $\pm 3\%$
T : Tantalum	J : $\pm 5\%$ K : $\pm 10\%$ L : $\pm 15\%$ M : $\pm 20\%$ P : $\pm 100\%$, -0% Z : $\pm 80\%$, -20%

20.2. Parts List

Ref. No.	Part No.	Part Name & Description	Remarks
CAPRISTORS			
CRA801	TP00842-51	TAPING GAP TERMINAL	△
CAPACITORS			
C003	ECA1HM4R7B	CAP E 4.7UF-50V	
C004	TCJ2VC1H150J	CAP C 15PF-J-50V	
C005	TCJ2VC1H150J	CAP C 15PF-J-50V	
C008	TCJ2VF1H103Z	CAP C .01UF-Z-50V	
C009	ECJ2VF1H104Z	CAP C .1UF-Z-50V	
C010	TCJ2VC1H680J	CAP C 68PF-J-50V	
C011	TCJ2VC1H680J	CAP C 68PF-J-50V	
C012	ECA1HM0R1B	CAP E 0.1UF/50V	
C013	TCJ2VC1H680J	CAP C 68PF-J-50V	
C016	ECA1AM101B	CAP E 100UF-10V	
C017	TCJ2VC1H680J	CAP C 68PF-J-50V	
C018	ECJ2VF1H103Z	CAP C .01UF-Z-50V CT-20G8G CT-20G8SG CT-20L8G	
C018	TCJ2VF1H103Z	CAP C .01UF-Z-50V CT-25L8G CT-25L8UG	
C019	ECA0JM102B	CAP E 1000UF-6.3V	
C020	ECA1CM102B	CAP E 1000UF/16V	
C021	TCJ2VF1H103Z	CAP C .01UF-Z-50V	
C031	TCJ2VC1H220J	CAP C 22PF-J-50V	
C032	ECA1AM470B	CAP E 47UF-10V	
C034	TCJ2VC1H390J	CAP C 39PF-J-50V	
C035	TCJ2VC1H120J	CAP C 12PF-J-50V	
C038	ECA1CM470B	CAP E 47UF/16V	
C039	TCJ2VB1H221K	CAP C 220PF-K-50V	
C041	ECA1HM2R2B	CAP E 2.2UF-50V	
C043	ECJ2VF1C105Z	CAP C 1.0UF-Z-16V	
C044	ECA0JM102B	CAP E 1000UF-6.3V	
C046	TCJ2VF1H103Z	CAP C .01UF-Z-50V	
C048	ECJ2VF1C105Z	CAP C 1.0UF-Z-16V	
C051	ECJ2VF1C105Z	CAP C 1.0UF-Z-16V	
C052	ECA1CM101B	CAP E 100UF/16V	
C053	ECJ2VF1C105Z	CAP C 1.0UF-Z-16V	
C054	ECJ2VF1C105Z	CAP C 1.0UF-Z-16V	
C055	ECJ2VF1C105Z	CAP C 1.0UF-Z-16V	
C056	ECJ2VF1C105Z	CAP C 1.0UF-Z-16V	
C057	ECEA1CN100UB	CAP E 10UF-16V	
C058	ECEA1CN100UB	CAP E 10UF-16V	
C059	ECJ2VF1C105Z	CAP C 1.0UF-Z-16V	
C060	ECEA1CN220UB	CAP E 22UF-16V	
C061	ECA1HM100B	CAP E 10UF/50V	
C062	ECA1HM100B	CAP E 10UF/50V	
C063	ECJ2VF1C104Z	CAP C .1UF-Z-16V	
C064	ECA1CM101B	CAP E 100UF/16V	
C066	TCJ2VC1H330J	CAP C 33PF-J-50V	
C067	TCJ2VC1H680J	CAP C 68PF-J-50V	
C068	ECA1CM100B	CAP E 10UF-16V	
C070	ECJ2VF1C104Z	CAP C .1UF-Z-16V	
C071	TCJ2VF1H103Z	CAP C .01UF-Z-50V	
C072	TCJ2VB1H221K	CAP C 220PF-K-50V	
C073	TCJ2VC1H101J	CAP C 100PF-J-50V	
C077	ECA1HM100B	CAP E 10UF/50V	
C079	TCJ2VC1H220J	CAP C 22PF-J-50V	
C083	TCJ2VF1H103Z	CAP C .01UF-Z-50V	
C085	ECJ2VB1C104K	CAP C .1UF-K-16V	
C350	ECA1CM101B	CAP E 100UF/16V	
C351	TCJ2VC1H101J	CAP C 100PF-J-50V CT-20G8G CT-20G8SG CT-20L8G	
C351	TCJ2VC1H331J	CAP C 330PF-J-50V CT-25L8G CT-25L8UG	
C352	TCJ2VC1H101J	CAP C 100PF-J-50V CT-20G8G CT-20G8SG CT-20L8G	
C352	TCJ2VC1H331J	CAP C 330PF-J-50V CT-25L8G CT-25L8UG	
C353	TCJ2VC1H151J	CAP C 150PF-J-50V CT-20G8G CT-20G8SG CT-20L8G	
C353	TCJ2VC1H331J	CAP C 330PF-J-50V CT-25L8G CT-25L8UG	
C354	ECKW3D102KBN	CAP C .001UF-K-2KVDC	
C357	EEANA1E1R0B	CAP E 1.0UF-25V	

Ref. No.	Part No.	Part Name & Description	Remarks
C359	ECA1CM471B	CAP E 470UF-16V	
C360	ECA1HM4R7B	CAP E 4.7UF-50V	
C370	ECA1HM100B	CAP E 10UF/50V CT-25L8G CT-25L8UG	
C403	ECEA1CN220UB	CAP E 22UF-16V	
C411	ECQB1H683JF3	CAP P .068UF-J-50V	
C451	ECA1HM2R2B	CAP E 2.2UF-50V	
C452	ECA1CM220B	CAP E 22UF-16V	
C454	ECA1VHG101B	CAP E 100UF-35V	
C455	ECA1EM102E	CAP E 1000UF-25V	
C458	ECA1HM010B	CAP E 1UF-50V	
C459	ECA1VHG471E	CAP E 470UF-35V	
C460	ECQB1224KF3	CAP P .22UF-K-100V	
C461	ECQB1104JF3	CAP P .10UF-J-100V CT-25L8G CT-25L8UG	
C462	ECJ2VF1H103Z	CAP C .01UF-Z-50V	
C501	ECCR1H221JC5	CAP C 220PF-J-50V	
C505	ECQB1H104JF3	CAP P .10UF-J-50V	
C506	ECKR2H102KB5	CAP C 1000PF-K-500V	
C510	ECCR2H100D5	CAP C 10PF-D-500V	
C512	ECA2CM100B	CAP E 10UF-160V	
C531	ECA1HM4R7B	CAP E 4.7UF-50V	△
C540	TCJ2VF1H103Z	CAP C .01UF-Z-50V	
C551	ECA1VHG471B	CAP E 470UF-35V	△
C554	ECKR2H561KB5	CAP C 560PF-K-500V	
C555	ECA2EM220E	CAP E 22UF-250V CT-25L8G CT-25L8UG	△
C555	ECA2EM470E	CAP E 47UF-250V CT-20G8G CT-20G8SG CT-20L8G	△
C556	ECA1CM471B	CAP E 470UF-16V	△
C557	ECKR2H102KB5	CAP C 1000PF-K-500V CT-25L8G CT-25L8UG	
C557	ECKR2H222KB5	CAP C 2200PF-K-500V CT-20G8G CT-20G8SG CT-20L8G	
C560	ECQB1104JFW	OR ECQB1104JF3	△
C561	ECEA1HN010UB	CAP E 1UF/50V	
C562	ECKR2H561KB5	CAP C 560PF-K-500V	
C563	ECWH12H362JS	CAP P 3600PF-J-1.2KV CT-20G8G CT-20G8SG CT-20L8G	△
C563	ECWH16622JVB	CAP P 6200PF-J-1.5KV CT-25L8G CT-25L8UG	△
C564	ECWH12H822JS	CAP P .0082UF-J-1.2KV CT-25L8G CT-25L8UG	△
C564	ECWH12H472JS	CAP P .0047UF-J-1.2KV CT-20G8G CT-20G8SG CT-20L8G	△
C565	ECKW3D561JBR	CAP P 560PF-J-2KV CT-25L8G CT-25L8UG	△
C565	ECKW3D821JBP	CAP C 820PF-J-2KV CT-20G8G CT-20G8SG CT-20L8G	△
C566	ECKW3D181JBP	CAP C 180PF-J-2KV	△
C568	ECQM4473JZW	CAP P .047UF-J-400V CT-20G8G CT-20G8SG CT-20L8G	△
C568	ECWF2224JBB	CAP P .22UF-J-200V CT-25L8G CT-25L8UG	△
C569	ECWF2394JSR	CAP M .39UF-J-200V CT-20G8G CT-20G8SG CT-20L8G	△
C569	ECWF2474JSR	CAP P .47UF-J-200V CT-25L8G CT-25L8UG	△
C570	ECA1CM221B	CAP E 10UF-16V	
C571	ECA1CM220B	CAP E 22UF-16V	
C572	ECA0JM221B	CAP E 220UF-6.3V	
C573	ECA1CM101B	CAP E 100UF/16V	
C575	ECKR2H471KB5	CAP C 470PF-K-500V	
C593	ECA1CM470B	CAP E 47UF/16V	
C605	TCJ2VF1H103Z	CAP C .01UF-Z-50V	
C606	ECA0JM221B	CAP E 220UF-6.3V	
C800	ECKR3A152KBP	CAP C 1500PF-K-1KVDC	
C801	ECKWAE472ZED	CAP C 4700PF-Z-500V	△
C802	ECKWAE472ZED	CAP C 4700PF-Z-500V	△
C803	ECKWAE472ZED	CAP C 4700PF-Z-500V	△
C805	EC0S2DA221BB	CAP E 220UF/200V CT-20G8G CT-20G8SG CT-20L8G	△
C805	EC0S2DA331BB	CAP E 330UF/200V CT-25L8G CT-25L8UG	△

Ref. No.	Part No.	Part Name & Description	Remarks
C806	ECQM4103KZW	CAP P .01UF-K-400V	
C808	ECA1HM470B	CAP E 47UF-50V	
C809	ECKR1H102KB5	CAP C .001UF-K-50V CT-25L8G CT-25L8UG	
C809	ECKR1H152KB5	CAP C 1500PF-K-50V CT-20G8G CT-20G8SG CT-20L8G	
C810	ECKR1H471KB5	CAP C 470PF-K-50V	
C812	ECQU2A224MVA	CAP P .22UF-M-250VAC	△
C813	ECQU2A153MVA	CAP P .015UF-M-250VAC	△
C814	ECQU2A153MVA	CAP P .015UF-M-250VAC	△
C820	ECA1CM101B	CAP E 100UF/16V	
C821	TCJ2VF1H103Z	CAP C .01UF-Z-50V	
C822	ECKR3A221KBP	CAP C 220PF-K-1KV	
C823	ECA1VM471B	CAP E 470UF-35V	△
C824	ECKR3A102KBP	CAP C 1000PF-K-1KV	
C825	EEUMG2C221S	CAP E 220UF-160V	△
C826	ECKR3A471KBP	CAP C 470PF-K-1KV	
C827	ECA1CM102B	CAP E 1000UF/16V	
C828	ECA160V33UE	CAP E 33UF/160V	△
C829	ECA1CM471B	CAP E 470UF-16V	
C830	ECA1CM471B	CAP E 470UF-16V	
C2201	ECA1HM4R7B	CAP E 4.7UF-50V	
C2202	ECA1HM2R2B	CAP E 2.2UF-50V	
C2203	ECA1HM4R7B	CAP E 4.7UF-50V	
C2204	AP106K016CAE	CAP T 10UF/16V	
C2205	ECA1HMR33B	CAP E .33UF-50V	
C2206	ECQB1H223JF3	CAP P .022UF-J-50V	
C2207	AP335K016CAE	CAP T 3.3UF/16V	
C2208	ECJ2VB1C104K	CAP C .1UF-K-16V	
C2209	ECJ2VB1C104K	CAP C .1UF-K-16V	
C2210	ECJ2VB1C104K	CAP C .1UF-K-16V	
C2212	ECQB1H473JF3	CAP P .047UF-J-50V	
C2213	ECA1HMR47B	CAP E .47UF-50V	
C2214	ECA1AM101B	CAP E 100UF-10V	
C2215	EEANA1E100B	CAP E 10UF-25V	
C2216	TCJ2VC1H100D	CAP C 10PF-J-50V	
C2217	ECJ2VB1H102K	CAP C .001UF-K-50V	
C2218	ECJ2VB1H102K	CAP C .001UF-K-50V	
C2219	ECJ2VF1C105Z	CAP C 1.0UF-Z-16V	
C2220	ECJ2VF1C105Z	CAP C 1.0UF-Z-16V	
C2301	ECA1EM102E	CAP E 1000UF-25V	
C2302	ECA1HM010B	CAP E 1UF-50V	
C2304	ECA1CM101B	CAP E 100UF/16V	
C2307	ECA1CM102B	CAP E 1000UF/16V	
C2308	ECKR1H103ZF3	CAP C .01UF-Z-50V	
C2312	ECA1HM010B	CAP E 1UF-50V	
C2313	ECA1EM220B	CAP E 22UF-25V	
C2317	ECA1CM102B	CAP E 1000UF/16V	
C2350	ECA1CM101B	CAP E 100UF/16V	
C3001	ECA1CM220B	CAP E 22UF-16V	
C3002	ECA1CM220B	CAP E 22UF-16V	
C3011	ECJ2VF1C105Z	CAP C 1.0UF-Z-16V	
C3012	ECA1HM010B	CAP E 1UF-50V	
C3013	ECA1CM100B	CAP E 10UF-16V	
C3014	ECA1CM100B	CAP E 10UF-16V	
C3018	ECA1HM010B	CAP E 1UF-50V	
C3019	ECJ2VF1C105Z	CAP C 1.0UF-Z-16V	
C3025	ECA1HM100B	CAP E 10UF/50V	
C3234	ECA1CM470B	CAP E 47UF/16V	
C3240	TCJ2VF1H103Z	CAP C .01UF-Z-50V	
DIODES			
D001	MAZ30680ML	DIODE	
D002	MA2C165001VT	DIODE	
D003	MAZ30510HL	DIODE	
D006	MAZ33000HL	DIODE	
D007	MAZ30510HL	DIODE	
D010	MAZ40510MF	DIODE ZENER	
D055	MAZ40330MF	DIODE ZENER	
D360	MA2C165001VT	DIODE	
D380	MA2C029WBF	DIODE	
D451	BOEAKL000008	DIODE RECTIFIER	
D452	MA2C165001VT	DIODE	
D505	D1NL40V70	DIODE	

Ref. No.	Part No.	Part Name & Description	Remarks
D531	MA2C165001VT	DIODE	△
D551	BOHAMM000072	DIODE FAST RECOVERY	△
D554	AU02V0	DIODE	△
D556	MA2C165001VT	DIODE	
D557	MAZ40270LF	DIODE ZENER	
D558	BOHANV000008	DIODE	
D559	EU2	DIODE	
D561	AU02V0	DIODE	△
D606	MA2C165001VT	DIODE	
D801	D3SBA60-4103	DIODE	△
D803	MAZ41200MF	DIODE ZENER	
D806	TAP2AA0003	PTC 3-OHM	△
D808	SARS01V1	DIODE	
D809	BOHAJP000015	DIODE	
D810	BOHAJP000015	DIODE	
D811	BOHAJP000015	DIODE	
D820	MA2C165001VT	DIODE	
D821	MAZ40470HF	DIODE ZENER	
D822	BOHAMM000103	DIODE	
D823	S3L60P154004	DIODE	△
D824	BOHAMM000072	DIODE FAST RECOVERY	
D2302	MAZ43000MF	DIODE ZENER	
D2305	CVS20A120MTA	DIODE	
D2307	CVS20A120MTA	DIODE	
D2350	MAZ40910LF	DIODE	
D2355	MAZ30510HL	DIODE	
D3001	MAZ40510MF	DIODE ZENER	
D3004	CVS20A120MTA	DIODE	
D3005	CVS20A120MTA	DIODE	
D3007	MAZ31100ML	DIODE ZENER	
D3008	MAZ31100ML	DIODE ZENER	
D3009	MAZ31100ML	DIODE ZENER	
D3010	MAZ31100ML	DIODE ZENER	
D3011	MAZ31100ML	DIODE ZENER	
D3012	MAZ31100ML	DIODE ZENER	
D3017	MAZ31100ML	DIODE ZENER	
D3018	MAZ31100ML	DIODE ZENER	
D3019	CVS20A120MTA	DIODE	
D3021	CVS20A120MTA	DIODE	
D3023	MAZ31100ML	DIODE ZENER	
D3024	MAZ31100ML	DIODE ZENER	
FUSES			
F801	XBA2A00101	FUSE 6.3A 125V	△
INTEGRATED CIRCUITS			
IC001	MN101E03GTB3	MPU	
IC002	TVR2AJ165S	EEPROM CT-20G8G CT-20G8SG	
IC002	TVR2AJ166S	EEPROM CT-20L8G CT-25L8G CT-25L8UG	
IC003	GP1UE282GK	IR SENSOR	
IC004	PST9128NR	RESET	
IC005	PQ3RD13	3.3V STBY REGULATOR	
IC451	AN5522	VERTICAL OUT AMP	
IC501	NC7SZU04M5X	H-DRIVE INVERTER	
IC551	AN78M09LB	9V VOLTAGE REGULATOR	
IC552	AN78M05LB	5V VOLTAGE REGULATOR	
IC801	STRW5634	MAIN POWER SUPPLY	△
IC802	0N3171RLF	OPTO-COUPLER	△
IC2201	AN5829S-E1V	MTS	
IC2301	AN17807A	AUDIO AMP	
IC3001	MM1114XFBE	VIDEO SWITCH	
COILS			
L002	EXCELSA39V	FERRITE BEAD	
L003	EXCELD35V	FERRITE BEAD	
L005	EXCELSA35V	FERRITE BEAD	
L006	EXCELSA35T	FERRITE BEAD	
L007	ELESN330JA	COIL PEAKING 33UH	
L008	GOC470KA0029	COIL PEAKING 47UH	
L010	GOC2R2KA0029	COIL PEAKING 2.2UH	
L011	EXCELSA26T	FERRITE BEAD	
L012	GOC2R2KA0029	COIL PEAKING 2.2UH	
L013	EXCELSA26T	FERRITE BEAD	
L014	ELESN180KA	COIL PEAKING 18UH	

Ref. No.	Part No.	Part Name & Description	Remarks
L015	ELESN3R3JA	COIL PEAKING 3.3UH	
L020	EXCELSA26T	FERRITE BEAD	
L023	EXCELSA26T	FERRITE BEAD CT-25L8G CT-25L8UG	
L032	EXCELSA26T	FERRITE BEAD	
L108	EXCELSA35V	FERRITE BEAD	
L110	G0C101KA0021	COIL PEAKING 100UH	
L245	EXCELSA35V	FERRITE BEAD	
L312	EXCELSA24T	FERRITE BEAD	
L351	G0C101KA0021	COIL PEAKING 100UH CT-25L8G CT-25L8UG	
L551	ELH5L4101	COIL CT-20G8G CT-20G8SG CT-20L8G	△
L551	ELH5L6128	COIL HORIZ. LINEARITY CT-25L8G CT-25L8UG	△
L552	EXCELSA39V	FERRITE BEAD	
L801	ELF15N011A	COIL CT-20G8G CT-20G8SG CT-20L8G	△
L801	ELF21V018A	COIL CT-25L8G CT-25L8UG	△
L802	ELIIN680KA	COIL PEAKING 68UH CT-20G8G CT-20G8SG CT-20L8G	
L802	TALL08T470KA	COIL CT-25L8G CT-25L8UG	
L803	TALL08T680KA	COIL	
L804	EXCELD35V	FERRITE BEAD CT-20G8G CT-20G8SG CT-20L8G	
L805	EXCELD35V	FERRITE BEAD CT-20G8G CT-20G8SG CT-20L8G	
L806	EXCELD35V	FERRITE BEAD	
L807	EXCELSA35V	FERRITE BEAD	
L808	EXCELSA35V	FERRITE BEAD	
L809	EXCELD35V	FERRITE BEAD CT-25L8G CT-25L8UG	
L810	EXCELD35V	FERRITE BEAD CT-25L8G CT-25L8UG	
L2301	EXCELD35V	FERRITE BEAD CT-20L8G CT-25L8G CT-25L8UG	
L2303	EXCELSA39T	FERRITE BEAD CT-25L8G CT-25L8UG	
L2305	EXCELSA35V	FERRITE BEAD	
TRANSISTORS			
Q001	2SD601ARTX	TRANSISTOR	
Q057	2SB709ARTX	TRANSISTOR	
Q058	2SB709ARTX	TRANSISTOR	
Q070	2SD601ARTX	TRANSISTOR	
Q092	2SB709ARTX	TRANSISTOR	
Q351	2SC3063RL	TRANSISTOR	
Q352	2SC3063RL	TRANSISTOR	
Q353	2SC3063RL	TRANSISTOR	
Q354	2SD601ARTX	TRANSISTOR	
Q355	2SD601ARTX	TRANSISTOR	
Q356	2SD601ARTX	TRANSISTOR	
Q357	2SD601ARTX	TRANSISTOR	
Q358	2SD601ARTX	TRANSISTOR	
Q359	2SD601ARTX	TRANSISTOR	
Q360	2SB709ARTX	TRANSISTOR	
Q361	2SB709ARTX	TRANSISTOR	
Q362	2SB709ARTX	TRANSISTOR	
Q411	2SB0710AQL	TRANSISTOR	
Q412	2SD0602AQL	TRANSISTOR	
Q451	2SB709ARTX	TRANSISTOR	
Q501	2SC1573AH	TRANSISTOR	
Q501	2SC4212HLB	TRANSISTOR CT-25L8G CT-25L8UG	
Q551	2SC562200VLK	TRANSISTOR CT-20G8G CT-20G8SG CT-20L8G	△
Q551	2SC5902000LK	TRANSISTOR CT-25L8G CT-25L8UG	△
Q560	2SB709ARTX	TRANSISTOR	
Q605	2SB709ARTX	TRANSISTOR	
Q606	2SD601ARTX	TRANSISTOR	
Q801	2SD601ARTX	TRANSISTOR	
Q802	2SD601ARTX	TRANSISTOR	
Q820	2SA1767QTA	TRANSISTOR	
Q830	2SB1011QRL	TRANSISTOR	

Ref. No.	Part No.	Part Name & Description	Remarks
Q831	2SC1473ATA	TRANSISTOR	
Q2350	2SB709ARTX	TRANSISTOR	
Q3001	2SD601ARTX	TRANSISTOR	
Q3002	2SD601ARTX	TRANSISTOR	
RELAYS			
RL801	K6BLAGA00042	RELAY	△
RESISTORS			
J327	ERDS2TJ471T	RES C 470-J-1/2W	
R001	ERJ6GEYJ103V	RES M 10K-J-1/10W	
R004	ERJ6GEYJ562V	RES M 5.6K-J-1/10W	
R005	ERJ6GEYJ471V	RES M 470-J-1/10W	
R007	ERJ6GEYJ471V	RES M 470-J-1/10W	
R008	ERJ6GEYJ223V	RES M 22K-J-1/10W	
R009	ERJ6GEYJ102V	RES M 1K-J-1/10W	
R014	ERJ6GEYJ472V	RES M 4.7K-J-1/10W	
R015	ERJ6GEYJ472V	RES M 4.7K-J-1/10W	
R016	ERJ6GEYJ221V	RES M 220-J-1/10W	
R017	ERJ6GEYJ221V	RES M 220-J-1/10W	
R018	ERJ6GEYJ472V	RES M 4.7K-J-1/10W	
R019	ERJ6GEYJ472V	RES M 4.7K-J-1/10W	
R020	ERJ6GEYJ221V	RES M 220-J-1/10W	
R021	ERJ6GEYJ101V	RES M 100-J-1/10W	
R022	ERJ6GEYJ101V	RES M 100-J-1/10W	
R023	ERJ6GEYJ102V	RES M 1K-J-1/10W	
R024	ERJ6GEYJ101V	RES M 100-J-1/10W	
R025	ERJ6GEYJ101V	RES M 100-J-1/10W	
R026	ERDS1FJ561P	RES C 560-J-1/2W	
R032	ERJ6GEYJ103V	RES M 10K-J-1/10W	
R033	ERJ6GEYJ222V	RES M 2.2K-J-1/10W	
R034	ERJ6GEYJ222V	RES M 2.2K-J-1/10W	
R035	ERJ6GEYJ332V	RES M 3.3K-J-1/10W	
R036	ERJ6GEYJ512V	RES M 5.1K-J-1/10W	
R037	ERJ6GEYJ912V	RES M 9.1K-J-1/10W	
R038	ERJ6GEYJ223V	RES M 22K-J-1/10W	
R039	ERDS2TJ102T	RES C 1K-J-1/4W	
R040	ERJ6GEYJ680V	RES M 68-J-1/10W	
R041	ERJ6GEYJ222V	RES M 2.2K-J-1/10W	
R042	ERJ6GEYJ222V	RES M 2.2K-J-1/10W	
R043	ERJ6GEYJ153V	RES M 15K-J-1/10W	
R044	ERJ6GEYJ101V	RES M 100-J-1/10W	
R045	ERDS2TJ101T	RES C 100-J-1/4W	
R046	ERJ6GEYJ102V	RES M 1K-J-1/10W	
R047	ERJ6GEYJ472V	RES M 4.7K-J-1/10W	
R048	ERJ6GEYJ101V	RES M 100-J-1/10W	
R050	ERJ6GEYJ102V	RES M 1K-J-1/10W	
R052	ERJ6GEYJ103V	RES M 10K-J-1/10W	
R053	ERJ6GEYJ101V	RES M 100-J-1/10W	
R055	ERJ6GEYJ103V	RES M 10K-J-1/10W	
R056	ERJ6GEYJ471V	RES M 470-J-1/10W	
R057	ERJ6GEYJ101V	RES M 100-J-1/10W	
R060	ERJ6GEYJ101V	RES M 100-J-1/10W	
R061	ERJ6GEYJ221V	RES M 220-J-1/10W	
R062	ERJ6GEYJ472V	RES M 4.7K-J-1/10W	
R063	ERDS2TJ101T	RES C 100-J-1/4W	
R064	ERJ6GEYJ473V	RES M 47K-J-1/10W	
R065	ERDS2TJ101T	RES C 100-J-1/4W	
R066	ERJ6GEYJ223V	RES M 22K-J-1/10W	
R067	ERJ6GEYJ223V	RES M 22K-J-1/10W	
R068	ERJ6GEYJ103V	RES M 10K-J-1/10W	
R069	ERJ6GEYJ123V	RES M 12K-J-1/10W	
R070	ERJ6GEYJ561V	RES M 560-J-1/10W	
R071	ERJ6GEYJ680V	RES M 68-J-1/10W	
R072	ERJ6GEYJ222V	RES M 2.2K-J-1/10W	
R073	ERJ6GEYJ471V	RES M 470-J-1/10W	
R074	ERJ6GEYJ471V	RES M 470-J-1/10W	
R075	ERJ6ENF3902V	RES M 39K-F-1/10W	
R076	ERJ6ENF6201V	RES M 6.2K-F-1/10W	
R077	ERJ6GEYJ103V	RES M 10K-J-1/10W	
R078	ERJ6GEYJ103V	RES M 10K-J-1/10W	
R080	ERJ6GEYJ183V	RES M 18K-J-1/10W	
R081	ERJ6GEYJ153	RES M 15K-J-1/10	
R082	ERJ6GEYJ183V	RES M 18K-J-1/10W	
R083	ERJ6GEYJ153V	RES M 15K-J-1/10W	

Ref. No.	Part No.	Part Name & Description	Remarks
R084	ERDS2TJ182T	RES C 1.8K-J-1/4W	
R087	ERDS2TJ221T	RES C 220-J-1/4W	
R088	ERJ6GEYJ223V	RES M 22K-J-1/10W	
R092	ERJ6GEYJ473V	RES M 47K-J-1/10W	
R093	ERJ6GEYJ331V	RES M 330-J-1/10W	
R351	ERG2FJ123H	RES M 12K-J-2W	
R352	ERG2FJ123H	RES M 12K-J-2W	
R353	ERG2FJ123H	RES M 12K-J-2W	
R354	ERC12GK272C	RES C 2.7K-K-1/2W	
R355	ERC12GK272C	RES C 2.7K-K-1/2W	
R356	ERC12GK272C	RES C 2.7K-K-1/2W	
R357	ERJ6ENF3300V	RES M 330-F-1/10W	
R358	ERJ6ENF3300V	RES M 330-F-1/10W	
R359	ERJ6ENF3300V	RES M 330-F-1/10W	
R360	ERJ6ENF1101V	RES M 1.1K-F-1/10W CT-20G8G CT-20G8SG CT-20L8G	
R360	ERJ6ENF9100V	RES M 910-F-1/10W CT-25L8G CT-25L8UG	
R361	ERJ6ENF1101V	RES M 1.1K-F-1/10W CT-20G8G CT-20G8SG CT-20L8G	
R361	ERJ6ENF9100V	RES M 910-F-1/10W CT-25L8G CT-25L8UG	
R362	ERJ6ENF1101V	RES M 1.1K-F-1/10W CT-20G8G CT-20G8SG CT-20L8G	
R362	ERJ6ENF9100V	RES M 910-F-1/10W CT-25L8G CT-25L8UG	
R363	ERJ6GEYJ101V	RES M 100-J-1/10W	
R364	ERJ6GEYJ101V	RES M 100-J-1/10W	
R365	ERJ6GEYJ101V	RES M 100-J-1/10W	
R369	ERDS2TJ393T	RES C 39K-J-1/4W CT-25L8G CT-25L8UG	
R370	ERDS2TJ224T	RES C 220K-J-1/4W CT-25L8G CT-25L8UG	
R371	ERJ6GEYJ101V	RES M 100-J-1/10W	
R372	ERJ6GEYJ101V	RES M 100-J-1/10W	
R373	ERJ6GEYJ101V	RES M 100-J-1/10W	
R374	ERJ6GEYJ102V	RES M 1K-J-1/10W	
R375	ERJ6GEYJ102V	RES M 1K-J-1/10W	
R376	ERJ6GEYJ102V	RES M 1K-J-1/10W	
R377	ERJ6ENF3300V	RES M 330-F-1/10W	
R378	ERJ6ENF3300V	RES M 330-F-1/10W	
R379	ERJ6ENF3300V	RES M 330-F-1/10W	
R380	ERJ6ENF1501V	RES M 1.5K-F-1/10W	
R381	ERJ6ENF1501V	RES M 1.5K-F-1/10W	
R382	ERJ6ENF1501V	RES M 1.5K-F-1/10W	
R383	ERJ6ENF3481V	RES M 3.48K-F-1/10W	
R384	ERJ6ENF7500V	RES M 750-F-1/10W	
R385	ERDS1FJ150P	RES C 15-J-1/2W	
R389	ERJ6GEYJ102V	RES M 1K-J-1/10W	
R390	ERJ6GEYJ102V	RES M 1K-J-1/10W	
R391	ERJ6GEYJ102V	RES M 1K-J-1/10W	
R411	ERJ6GEYJ682V	RES M 6.8K-J-1/10W	
R412	ERJ6GEYJ471V	RES M 470-J-1/10W	
R413	ERJ6GEYJ103V	RES M 10K-J-1/10W	
R414	ERJ6GEYJ471V	RES M 470-J-1/10W	
R451	ERDS1FJ1R0P	RES C 1.0-J-1/2W CT-25L8G CT-25L8UG	
R451	ERDS1FJ1R2P	RES C 1.2-J-1/2W CT-20G8G CT-20G8SG CT-20L8G	
R453	ERJ6GEYJ333V	RES M 33K-J-1/10W	
R454	ERJ6GEYJ243V	RES M 24K-J-1/10W CT-20G8G CT-20G8SG CT-20L8G	
R454	ERJ6GEYJ363V	RES M 36K-J-1/10W CT-25L8G CT-25L8UG	
R455	ERJ6GEYJ103V	RES M 10K-J-1/10W	
R456	ERG3FJ151	RES M 150-J-3W	
R457	ERDS1FJ1R0P	RES C 1.0-J-1/2W	
R458	ERJ6GEYJ123V	RES M 12K-J-1/10W	
R459	ERJ6GEYJ122V	RES M 1.2K-J-1/10W CT-20G8G CT-20G8SG CT-20L8G	
R459	ERJ6GEYJ152V	RES M 1.5K-J-1/10W CT-25L8G CT-25L8UG	
R462	ERJ6GEYJ472V	RES M 4.7K-J-1/10W	
R463	ERJ6GEYJ473V	RES M 47K-J-1/10W	
R464	ERJ6GEYJ103V	RES M 10K-J-1/10W	
R468	ERJ6ENF1962V	RES M 19.6K-F-1/10W	

Ref. No.	Part No.	Part Name & Description	Remarks
R469	ERJ6ENF5621V	RES M 5.62K-F-1/10W	
R471	ERJ6GEYJ223V	RES M 22K-J-1/10W CT-25L8G CT-25L8UG	
R471	ERJ6GEYJ333V	RES M 33K-J-1/10W CT-20G8G CT-20G8SG CT-20L8G	
R504	ERDS2TJ102T	RES C 1K-J-1/4W	
R505	ERJ6GEYJ562V	RES M 5.6K-J-1/10W	
R506	ERGLS562P	RES M 5.6K-J-1W	
R507	EROS2THF1802	RES M 18K-F-1/4W	△
R509	ERJ6ENF1002V	RES M 10K-F-1/10W	△
R510	ERG3FJ472	RES M 4.7K-J-3W CT-20G8G CT-20G8SG CT-20L8G	△
R510	ERG3FJ622	RES M 6.2K-J-3W CT-25L8G CT-25L8UG	△
R511	ERG3FJ622	RES M 6.2K-J-3W CT-25L8G CT-25L8UG	△
R512	ERJ6GEYJ222V	RES M 2.2K-J-1/10W	
R514	ERJ6GEYJ392V	RES M 3.9K-J-1/10W	
R515	ERDS2TJ101T	RES C 100-J-1/4W	
R532	ERJ6ENF2202V	RES M 22K-F-1/10W	△
R533	ERJ6ENF1003V	RES M 100K-F-1/10W	△
R540	ERJ6GEYJ105V	RES M 1M-J-1/10W	
R541	ERDS2TJ274T	RES C 27K-J-1/4W	
R542	ERJ6GEYJ124V	RES M 120K-J-1/10W	
R551	ERX12SJR47P	RES M .47-J-1/2W	△
R552	ERDS1FJ1R0T	RES C 1.0-J-1/2W	△
R557	ERJ6GEYJ103V	RES M 10K-J-1/10W	
R558	ERQ1CKPR56S	RES F .56-K-1W CT-25L8G CT-25L8UG	△
R558	ERQ2CJP1R5S	RES F 1.5-J-2W CT-20G8G CT-20G8SG CT-20L8G	△
R559	ERG2FJ683H	RES M 12K-J-2W	
R561	ERG2FJ102H	RES M 1K-J-2W	
R562	ERG2FJ270H	RES M 27-J-2W	
R563	ERG3FJ150H	RES M 15-J-3W	
R564	ERDS2TJ104T	RES C 100K-J-1/4W	
R565	ERDS2TJ393T	RES C 39K-J-1/4W CT-25L8G CT-25L8UG	
R565	EROS2TKF9762	RES M 97.6K-F-1/4W CT-20G8G CT-20G8SG CT-20L8G	
R592	ERJ6GEYJ472V	RES M 4.7K-J-1/10W	
R605	ERDS2TJ103T	RES C 10K-J-1/4W	
R606	ERJ6GEYJ562V	RES M 5.6K-J-1/10W	
R607	ERJ6GEYJ102V	RES M 1K-J-1/10W	
R608	ERJ6GEYJ104V	RES M 100K-J-1/10W	
R801	ERF7ZK1R5	RES W 1.5-K-7 CT-25L8G CT-25L8UG	
R802	ERG2FJ104H	RES M 100K-J-2W	
R804	ERG1DJ224P	RES M220K-J-1W	
R805	ERX2FZJR15H	RES M .18-J-2W	△
R806	ERX12SJR15P	RES M 1.5-J-1/2W	△
R807	ERDS2TJ681T	RES C 680-J-1/4W	
R808	ERX12SJR15P	RES M 1.5-J-1/2W	
R809	ERDS2TJ472T	RES C 4.7K-J-1/4	
R810	ERDS2TJ221T	RES C 220-J-1/4W	
R815	ERC12ZGK825D	RES C 8.2MEG-K-1/2W	△
R817	ERX3FJ6R8	RES M 6.8-J-3W CT-20G8G CT-20G8SG CT-20L8G	△
R821	ERDS1FJ1R0T	RES C 1.0-J-1/2W CT-25L8G CT-25L8UG	
R821	ERDS1FJ1R5T	RES C 1.5-J-1/2W CT-20G8G CT-20G8SG CT-20L8G	
R822	ERDS1FJ1R0T	RES C 1.0-J-1/2W CT-25L8G CT-25L8UG	
R822	ERDS1FJ1R5T	RES C 1.5-J-1/2W CT-20G8G CT-20G8SG CT-20L8G	
R823	ERDS1FJ272T	RES C 2.7K-J-1/2W	
R824	ERDS2TJ223T	RES C 22K-J-1/4W	
R825	ERDS2TJ272T	RES C 2.7K-J-1/4W	
R827	ERJ6GEYJ153V	RES M 15K-J-1/10W	
R828	ERJ6GEYJ104V	RES M 100K-J-1/10W	
R829	ERJ6GEYJ104V	RES M 100K-J-1/10W	
R830	ERG2FJ273H	RES M 27K-J-2W	
R831	ERDS2TJ682T	RES C 6.8K-J-1/4W	
R832	ERJ6GEYJ122V	RES M 1.2K-J-1/10W CT-25L8G CT-25L8UG	

Ref. No.	Part No.	Part Name & Description	Remarks
R832	ERJ6GEYJ512V	RES M 5.1K-J-1/10W CT-20G8G CT-20G8SG CT-20L8G	
R833	ERJ6GEYJ473V	RES M 4.7K-J-1/10W	
R834	ERJ6GEYJ472V	RES M 4.7K-J-1/10W	
R837	ERJ6GEYJ103V	RES M 10K-J-1/10W	
R838	ERJ6GEYJ103V	RES M 10K-J-1/10W	
R850	ERQ12HJR22P	RES F .22-J-1/2W CT-25L8G CT-25L8UG	△
R850	ERQ12HJR56P	RES F .56-J-1/2W CT-20G8G CT-20G8SG CT-20L8G	△
R202	ERJ6GEYJ222V	RES M 2.2K-J-1/10W	
R2201	ERJ6GEYJ224V	RES M 220K-J-1/10W	
R2203	ERJ6GEYJ272V	RES M 2.7K-J-1/10W	
R2204	ERJ6GEYJ272V	RES M 2.7K-J-1/10W	
R2205	ERDS2TJ101T	RES C 100-J-1/4W	
R2206	ERDS2TJ273T	RES C 27K-J-1/4W	
R2207	ERJ6GEYJ152V	RES M 1.5K-J-1/10W	
R2208	ERJ6GEYJ152V	RES M 1.5K-J-1/10W	
R2301	ERQ2CJP5R6S	RES F 5.6-J-2W CT-20G8G CT-20G8SG CT-20L8G	
R2351	ERJ6GEYJ102V	RES M 1K-J-1/10W	
R2352	ERJ6GEYJ152V	RES M 1.5K-J-1/10W	
R2357	ERJ6GEYJ472V	RES M 4.7K-J-1/10W	
R2370	ERJ6GEYJ222V	RES M 2.2K-J-1/10W	
R3002	ERJ6GEYJ221V	RES M 220-J-1/10W	
R3003	ERJ6GEYJ221V	RES M 220-J-1/10W	
R3004	ERDS2TJ101T	RES C 100-J-1/4W	
R3005	ERJ6GEYJ334V	RES M 330K-J-1/10W	
R3006	ERJ6GEYJ151V	RES M 150-J-1/10W	
R3007	ERJ6GEYJ151V	RES M 150-J-1/10W	
R3008	ERJ6ENF75R0V	RES M 75.0-F-1/10W	
R3009	ERJ6GEYJ682V	RES M 6.8K-J-1/10W	
R3010	ERJ6GEYJ334V	RES M 330K-J-1/10W	
R3011	ERJ6GEYJ682V	RES M 6.8K-J-1/10W	
R3012	ERDS2TJ101T	RES C 100-J-1/4W	
R3013	ERJ6ENF75R0V	RES M 75.0-F-1/10W	
R3014	ERJ6ENF75R0V	RES M 75.0-F-1/10W	
R3015	ERJ6ENF75R0V	RES M 75.0-F-1/10W	
R3016	ERDS2TJ181T	RES C 180-J-1/4W	
R3017	ERDS2TJ181T	RES C 180-J-1/4W	
R3018	ERDS2TJ101T	RES C 100-J-1/4W	
R3019	ERJ6GEYJ682V	RES M 6.8K-J-1/10W	
R3020	ERJ6GEYJ682V	RES M 6.8K-J-1/10W	
R3021	ERDS2TJ101T	RES C 100-J-1/4W	
R3022	ERDS2TJ101T	RES C 100-J-1/4W	
R3023	ERDS2TJ101T	RES C 100-J-1/4W	
R3024	ERDS2TJ101T	RES C 100-J-1/4W	
R3026	ERDS2TJ101T	RES C 100-J-1/4W	
R3027	ERDS2TJ101T	RES C 100-J-1/4W	
R3034	ERJ6GEYJ471V	RES M 470-J-1/10W	
R3035	ERJ6GEYJ562V	RES M 5.6K-J-1/10W	
R3036	ERJ6GEYJ183V	RES M 18K-J-1/10W	
R3037	ERJ6GEYJ471V	RES M 470-J-1/10W	
R3038	ERJ6GEYJ562V	RES M 5.6K-J-1/10W	
R3039	ERJ6GEYJ183V	RES M 18K-J-1/10W	
R3041	ERJ6GEYJ472V	RES M 4.7K-J-1/10W	
R3042	ERJ6GEYJ472V	RES M 4.7K-J-1/10W	
R3101	ERJ6GEYJ334V	RES M 330K-J-1/10W	
R3102	ERJ6GEYJ334V	RES M 330K-J-1/10W	
R3103	ERJ6GEYJ334V	RES M 330K-J-1/10W	
R3104	ERJ6GEYJ334V	RES M 330K-J-1/10W	
SWITCHES			
S001	EVQPF106K	SWITCH	
S002	EVQPF106K	SWITCH	
S003	EVQPF106K	SWITCH	
S004	EVQPF106K	SWITCH	
S005	EVQPF106K	SWITCH	
S008	EVQPF106K	SWITCH	
S009	EVQPF106K	SWITCH	
TRANSFORMERS			
T501	ETH19Y211AZ	TRANSFORMER	
T551	TLF2AA004	TRANSFORMER FLYBACK CT-25L8G CT-25L8UG	△

Ref. No.	Part No.	Part Name & Description	Remarks
T551	ZTFN32501A	TRANSFORMER FLYBACK CT-20G8G CT-20G8SG CT-20L8G	△
T801	ETS29AS1N5NC	TRANSFORMER CT-20G8G CT-20G8SG CT-20L8G	△
T801	SRW35EC-U07V	TRANSFORMER SWITCHING CT-25L8G CT-25L8UG	△
T3001	TF0402B04P03	TRANSFORMER	
T3002	TF0402B04P03	TRANSFORMER	
CRYSTALS / FILTERS			
X001	A1100005BD	CRYSTAL	
OTHERS			
TNR001	ENG36621G	TUNER	△
M001	TSX2AA0361	LINE CORD AC	
M002	TJSC00300	CRT SOCKET	
1	A51KQK99X01	CRT 20 INCH, DEFLECTION YOKE, PURITY AND CONVERGENCE RINGS CT-20G8G CT-20G8SG CT-20L8G	△
	A63QDB891X	CRT 25 INCH CT-25L8G CT-25L8UG	△
2	TLY2AA027	DEFLECTION YOKE CT-25L8G CT-25L8UG	△
3	JH291U-009	PURITY AND CONVERGENCE RINGS CT-25L8G CT-25L8UG	
4	TSP2AA008	COIL DEGAUSSING CT-20G8G CT-20G8SG CT-20L8G	△
	TSP2AA028	COIL DEGAUSSING CT-25L8G CT-25L8UG	△
5	TKF3A01BA3	ASSY. DAG GND CT-20G8G CT-20G8SG CT-20L8G	
	TKF3A01DF3	ASSY. DAG GND CT-25L8G CT-25L8UG	
M003	TMM2A30702	WEDGE YOKE	
M004	OFMK014ZZ	CONVERGENCE CORRECTOR STRIP	
M005	TSN40007	MAGNET PURITY CT-25L8G CT-25L8UG	
M006	TSN63115-4	MAGNET PURITY CT-20G8G CT-20G8SG CT-20L8G	
6	TXFKY13GSER	ASSY CABINET FRONT CT-20G8G	
	TXFKY14GSER	ASSY CABINET FRONT CT-20L8G	
	TXFKY15GSER	ASSY CABINET FRONT CT-20G8SG	
	TXFKY16GSER	ASSY CABINET FRONT CT-25L8G CT-25L8UG	
7	TXFKU11GSER	ASSY CABINET BACK CT-20G8G CT-20G8SG CT-20L8G	
	TXFKU12FSER	ASSY CABINET BACK CT-25L8G CT-25L8UG	
8	TKX2AA00401	IR GUIDE CT-20G8G CT-20G8SG CT-20L8G	
	TKX2AA00403	IR GUIDE CT-25L8G CT-25L8UG	
9	TAS2AA0012	SPEAKER 16-OHM 1.5W	
10	TBM2A10141	BADGE PANASONIC CT-20G8G	
	TBM2A10143	BADGE PANASONIC CT-20G8SG CT-20L8G CT-25L8G CT-25L8UG	
11	TBX2AA1303G	BUTTON 7-KEY CT-25L8G CT-25L8UG	
	TBX2AA1701GS	BUTTON 7-KEY CT-20G8G	
	TBX2AA1702G	BUTTON 7-KEY CT-20L8G	
	TBX2AA1702GS	BUTTON 7-KEY CT-20G8SG	
JK3001	TJB2AA0221	TERMINAL A/V 8P CT-20L8G CT-25L8G CT-25L8UG	
JK3001	TJB2A9064B	ASSY. JACK A/V CT-20G8G CT-20G8SG	
JK3002	TJB2AA0046	TERMINAL FRONT A/V	
JK3003	TJB2AA0171	TERMINAL S-VIDEO CT-20G8G CT-20G8SG	
OTHER ACCESSORIES			
M007	TQB2AA0452-1	OWNERS MANUAL CT-20G8G CT-20G8SG CT-20L8G	
M008	TQB2AA0461	OWNERS MANUAL CT-25L8G CT-25L8UG	

Ref. No.	Part No.	Part Name & Description	Remarks
M009	EUR7713010	REMOTE CONTROL	
M010	UR77EC1303A	BATTERY COVER REMOTE CONTROL	